

# KLIMBER 3 P



User *manual*



**PIVIUK**

EN/LTF D

# KLIMBER 3 P

## BORN TO COMPETE

### WELCOME

We welcome you to our team and thank you for the trust you have placed in us by choosing a Niviuk paraglider.

We would like you to share the enthusiasm with which we have created this paraglider and the importance and care with which we have developed the design and manufacture of this new model. All this, in order to be able to offer you the maximum pleasure in every flight under a Niviuk paraglider.

We would like to introduce you to the KLIMBER 3 P. We keep improving our P series two-liner: super compact, ultra-light and high performance. We put all our knowledge, technologies and experience at the service of pilots who want to achieve the best results in hike & fly and cross-country paragliding. With a competitive character, it has been designed for the X-Alps. Competitive in nature, it has been conceived for X-Alps and is within the reach of all pilots.

The KLIMBER 3 P will allow you to fly long distances with maximum comfort, lightness, safety and stability.

We are confident you will enjoy flying this glider and will soon discover the meaning of our motto:

*“The importance of small details to make great things happen”.*

This is the user manual and we recommend you read it carefully.

### Niviuk Gliders & Air Games SL

C/ Del Ter 6 - nave D  
17165 La Cellera de Ter - Girona - Spain  
+34 972 422 878  
info@niviuk.com  
[www.niviuk.com](http://www.niviuk.com)



HIKE & FLY



CROSS-COUNTRY



COMPETITION

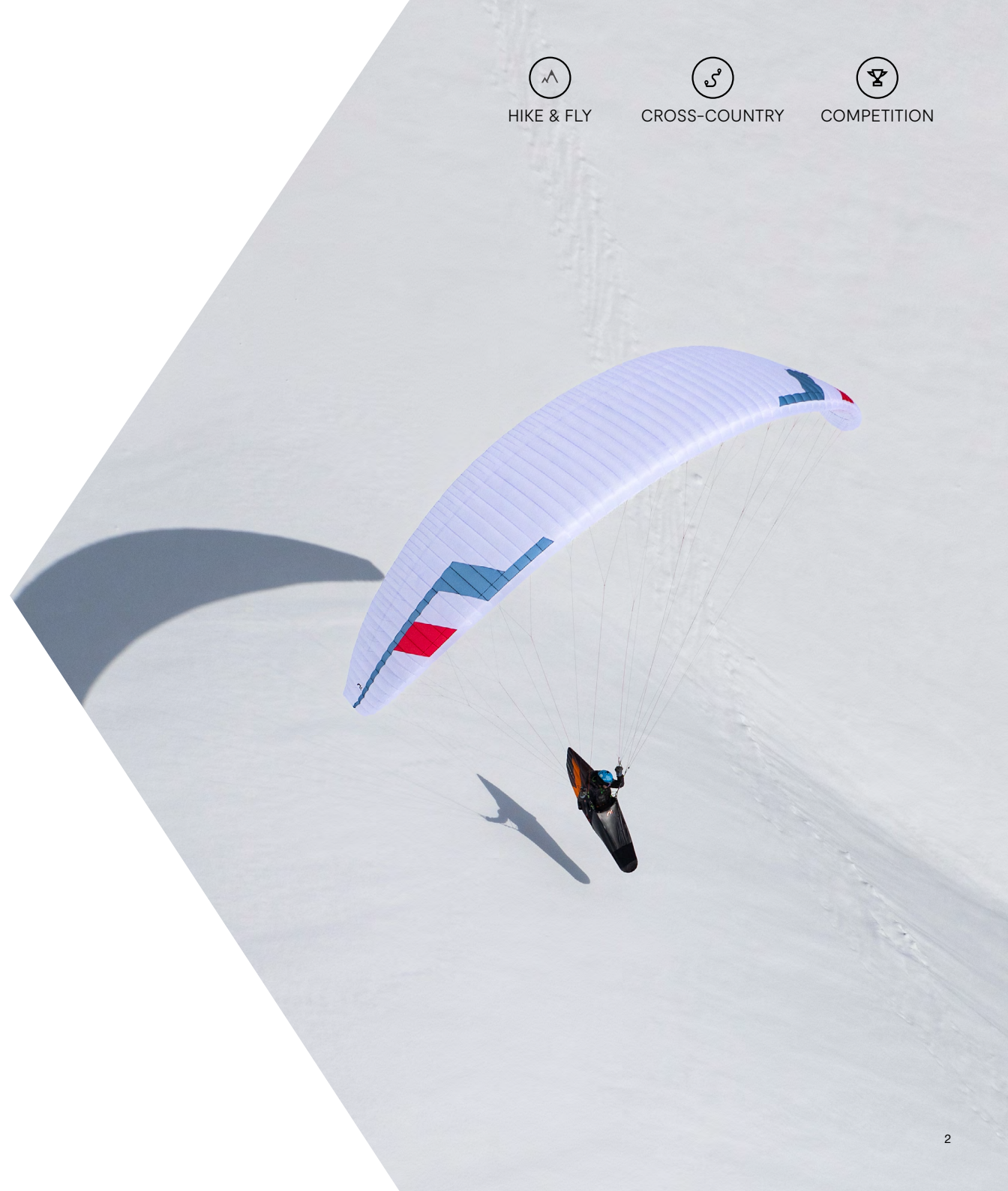

# USER MANUAL

This manual provides you with the necessary information on the main characteristics of your new paraglider.

Whilst it provides information on the wing, it cannot be viewed as an instructional handbook and does not offer the training required to fly this type of paraglider. Training can only be undertaken at a certified paragliding school and each country has its own system of licensing. Only the aeronautical authorities of respective countries can determine pilot competence.

The information in this manual is provided in order to warn you against adverse flying situations and potential dangers.

Equally, we would like to remind you that it is important to carefully read all the contents of your new KLIMBER 3 P manual.

Misuse of this equipment could lead to severe injuries or death. The manufacturers and dealers cannot be held responsible for misuse of the paraglider. It is the responsibility of the pilot to ensure the equipment is used correctly.



# CONTENTS

<b>1. CHARACTERISTICS</b> .....	<b>4</b>	<b>7.1 MAINTENANCE</b> .....	<b>13</b>
1.1 WHO IS IT DESIGNED FOR? .....	4	7.2 STORAGE .....	14
1.2 CERTIFICATION .....	4	7.3 CHECKS AND INSPECTIONS .....	14
1.3 IN-FLIGHT BEHAVIOR .....	4	7.4 REPAIRS .....	15
1.4 TECHNOLOGIES, CONSTRUCTION, MATERIALS .....	4	<b>8. SAFETY AND RESPONSIBILITY</b> .....	<b>16</b>
1.5 ELEMENTS, COMPONENTS .....	7	<b>9. GUARANTEE</b> .....	<b>16</b>
<b>2. UNPACKING AND ASSEMBLY</b> .....	<b>7</b>	<b>10. ANNEXES</b> .....	<b>17</b>
2.1 CHOOSING THE RIGHT LOCATION .....	7	10.1 TECHNICAL SPECIFICATIONS .....	17
2.2 PROCEDURE .....	7	10.2 MATERIALS TECHNICAL DATA .....	18
2.3 CONNECTING THE HARNESS .....	7	10.3 LINE PLAN .....	19
2.4 HARNESS TYPE .....	7	10.4 RISER PLAN .....	20
2.5 SPEED-BAR .....	7	10.5 LINE MEASUREMENTS KLIMBER 3 P 20.....	21
2.5.1 SPEED SYSTEM ASSEMBLY .....	8	10.6 LINE MEASUREMENTS KLIMBER 3 P 21.....	21
2.5.2 CHANGING THE RISER CORDS .....	8	10.7 LINE MEASUREMENTS KLIMBER 3 P 23.....	22
2.6 INSPECTION AND WING INFLATION ON THE GROUND .....	8	10.8 CERTIFICATION .....	23
2.7 ADJUSTING THE BRAKES .....	8		
<b>3. THE FIRST FLIGHT</b> .....	<b>8</b>		
3.1 CHOOSING THE RIGHT LOCATION .....	8		
3.2 PREPARATION .....	8		
3.3 FLIGHT PLAN .....	9		
3.4 PRE-FLIGHT CHECK .....	9		
3.5 WING INFLATION, CONTROL AND TAKEOFF.....	9		
3.6 LANDING .....	9		
3.7 PACKING .....	9		
<b>4. IN FLIGHT</b> .....	<b>9</b>		
4.1 FLYING IN TURBULENCE .....	9		
4.2 POSSIBLE CONFIGURATIONS .....	10		
4.3 ACCELERATED FLIGHT.....	11		
4.4 FLYING WITHOUT BRAKE LINES .....	11		
4.5 LINE KNOT(S) IN FLIGHT .....	11		
<b>5. LOSING ALTITUDE</b> .....	<b>11</b>		
5.1 BIG EARS .....	11		
5.2 B3 TECHNIQUE .....	12		
5.3 B-LINE STALL .....	12		
5.4 SPIRAL DIVE .....	12		
5.5 SLOW DESCENT TECHNIQUE .....	13		
<b>6. SPECIAL METHODS</b> .....	<b>13</b>		
6.1 TOWING .....	13		
6.2 ACROBATIC FLIGHT.....	13		
<b>7. CARE AND MAINTENANCE</b> .....	<b>13</b>		

# 1. CHARACTERISTICS

## 1.1 WHO IS IT DESIGNED FOR?

The KLIMBER 3 P is the perfect partner for mountain lovers. Ideal for experienced pilots looking to reach higher peaks and cover long distances with an ultralight glider.

A high performance machine, perfect for complicated launches and landings. The wing stays solid and efficient, even in turbulent air. It is our P Series racing model par excellence. A high level competition wing within the reach of all pilots.

Hike & fly and vol-biv – go big distances with a paraglider that has evolved in terms of glide and thermal performance. Its volume has been reduced thanks to the new ultra-light internal structure and the use of Nitinol allows a more compact and practical packing for those multi-day adventures.

## 1.2 CERTIFICATION

The KLIMBER 3 P has been submitted for the European EN and LTF certification. All certification tests were performed at the Swiss testing house Air Turquoise. All sizes passed the load, shock and flight tests.

The load test proved that the wing can withstand the stipulated 8G.

The shock test proved that the wing can resist 800 daN of force.

The flight test resulted in the following certification of the KLIMBER 3 P for all sizes (20, 21 and 23):

EN D  
LTF D

We recommend that only pilots who are familiar with gliders of this certification or above fly this paraglider.

Only the aeronautical authorities of respective countries can determine pilot competence.

We recommend pilots read the flight test report carefully, especially the comments of the test pilot. The report contains all the necessary information on how the paraglider reacts during each of the tested manoeuvres.

It is important to note that different size wings will react differently during manoeuvres. Even within the same size, at maximum or minimum load, the behaviour and reactions of the wing may vary.

- Description of flight characteristics of LTF/EN D paragliders: paragliders with demanding and unique flight characteristics with potentially violent reactions in turbulence and to pilot errors. Normal flight recovery requires precise pilot intervention.
- Description of the pilot skills required for an EN D wing: for pilots trained in recovery techniques, who fly very actively, have significant experience of flying in turbulent conditions and who accept the consequences of flying with this type of wing.

For further information on the flight test and the corresponding certification, please see the final pages of this manual or see or visit the Downloads section at <https://niviuk.com/en/downloads>

## 1.3 IN-FLIGHT BEHAVIOUR

Niviuk developed this wing by adopting very specific goals: to offer the best possible features, excellent handling, to make flying easier for the pilot.

Our other aims were to achieve optimal performance while maintaining the highest level of safety. To ensure that the wing transmits the maximum feedback in an understandable and comfortable way so that the pilot can focus on piloting and enjoying the flight. And, with active piloting, take advantage of all favourable conditions.

In all aspects of flight, the wing is very solid and stable. The glide is smooth, even when fully accelerated. During glides, the wing maintains altitude and the wing remains stable. Improved turn precision means handling is less physical and provides better feedback. Inflating the wing is much easier and gentler, without overshooting.

Flying this wing is very intuitive, with clear and useful feedback about the airmass. It responds to the pilot's inputs effectively and even in thermic and turbulent conditions it remains stable and solid.

The KLIMBER 3 P flies efficiently. It enters thermals with sufficient speed to centre in the lift and climbs progressively. The handling is progressive and effective for even more flying pleasure under an exciting wing of extraordinary quality.

It is lightweight; even lighter in flight and easy to pilot, with outstanding turbulence buffering and a surprising range of speed for incredible glides.

## 1.4 TECHNOLOGIES, CONSTRUCTION, MATERIALS

The KLIMBER 3 P benefits from all the construction and assembly techniques used in our factory. It has all the current technology and accessories available to improve pilot comfort whilst increasing safety and performance.

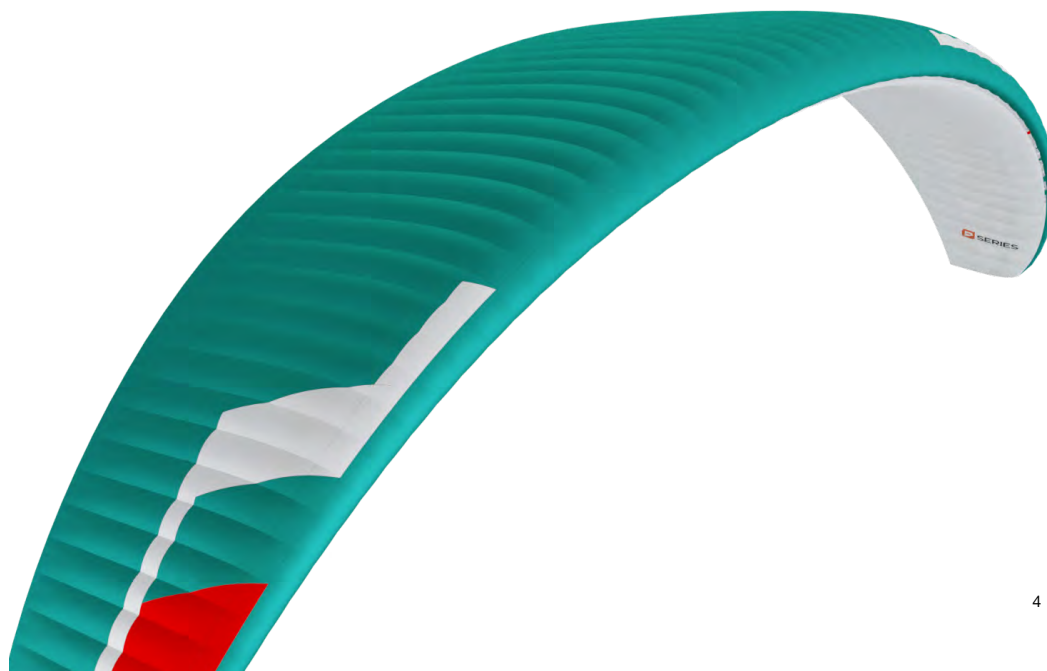

In the design of all Niviuk products the team aims to ensure development and continuous improvement. The technologies developed in recent years have allowed us to develop greater, better wings. It is in this context that we would like to introduce the technologies included in this new model:

**RAM Air Intake** – The system is characterised by the arrangement of the air inlets, to ensure optimal maintenance of internal pressure across the the whole range of angles of attack.

The result? Having greater internal pressure means better tolerance of turbulence, greater consistency of the profile shape across the speed range; excellent handling at low speed is achieved by allowing the pilot to extend the braking limit, there is a lower risk of collapse and consequently, greater control and safety.

**Titanium Technology (TNT)** – a revolutionary technique using titanium. Using Nitinol in the internal construction provides a more uniform profile and reduces the weight to gain efficiency in flight. Nitinol provides the highest level of protection against deformation, heat or breaks.

Nitinol now features in all our wings.

**SLE (Structured Leading Edge)** – SLE is the application of Nitinol rods in the leading edge. This technology provides increased strength and stability by maintaining the shape of the aerofoil throughout all phases of flight. This increases performance, efficiency and stability, absorbs turbulence better and makes the wing much more durable over time.

**3D Pattern Cut Optimisation (3DP)** – this involves placing the fabric of each panel in one direction only, taking as a reference its location on the leading edge. It has been proved that, if the cloth pattern is correctly aligned to the direction of the load axes, the material deforms much less flight after flight, so the leading edge keeps its shape better and is much more durable over time.

Over the years, the design of our paragliding and paramotoring wings has evolved a lot, with a positive and specific advancement of the leading edge.

**3D Leading Edge (3DL)** - this means adjusting the material of the leading edge to avoid ballooning and the creases that form in this curved area of the wing. Specifically, the leading edge is divided into “sub-panels” sewn into each of the cells at the front of the glider. As a result, the tension of the leading edge cloth is perfectly uniform, increasing the performance and durability of the glider.

**Structured Trailing Edge (STE)** - the application of Nitinol rods in the trailing edge makes up the STE. Thanks to this technology, the shape of the profile is maintained, especially at high speeds, the load distribution and strength are improved, reducing creases and drag while increasing the performance of the sail.

**Drag Reduction Structure (DRS)** – the DRS aims to reduce the adverse pressure gradient and drag by optimising the aerodynamic shape of the wing. Its application makes the airflow direction much more progressive at the trailing edge. This increases performance without reducing safety and control of the wing.

**Radial Sliced Diagonal (RSD)** - this involves a redesign of the internal structure of the wing. It incorporates independent and efficiently oriented diagonals, i.e. following the direction of the cloth. This improves strength, reduces the overall weight of the glider and avoids deformation.

In order to improve stress distribution and reduce the number of attachment points and lines, most wings already have these diagonals, which are connected from the attachment points to the adjacent profiles.

**Interlock System (IKS)** – the IKS is a connection system that allows the risers to be connected to different parts of the wing, such as the lines or the harness. The IKS technology is a step towards greater lightness in wings and equipment, without sacrificing effectiveness and providing the same degree of safety and strength.

IKS1000 is included in the pack.

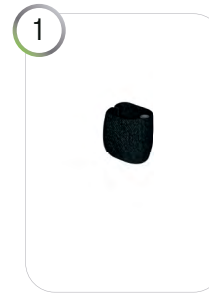

1 Locate the elastic sleeve's inner small diameter tube.



2 Push the IKS line through it.



3 Push now the IKS line through the lines and the riser. The reinforced end with the black tab should be located on the riser side.

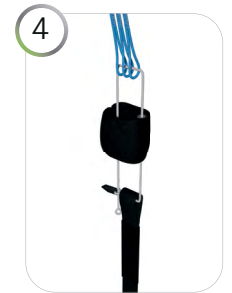

4 Push the upper looped end downward through the elastic sleeve (not small diameter tube) and then through the reinforced loop end where the black tab is located.



5 Continue with the procedure in a counterclockwise motion by pushing the looped end through the riser.



6 Push the looped end first upward through the elastic sleeve (not small diameter tube) and through the lines again following the same pattern.

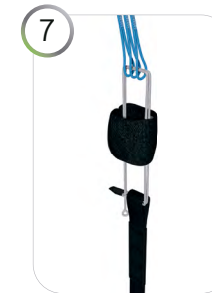

7 Push the looped end downward through the elastic sleeve (not small diameter tube) first, and then through the loop with the reinforced end (black tab) once more.

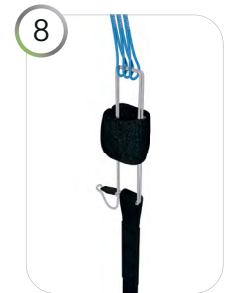

8 Push the reinforced end loop (black tab) through the looped end to secure them together.



9 Pull tight to secure the knot and connection.



10 Check the entire assembly.

The use of these technologies is a big technological leap forward in building wings and a big improvement in flight comfort.

For the construction process of the KLIMBER 3 P we use the same criteria, quality controls and manufacturing processes as in the rest of our range. From Olivier Nef's computer to fabric cutting, the operation does not allow for even a millimetre of error. The cutting of each wing component is performed by a rigorous, extremely meticulous, automated computer laser-cutting robotic arm.

This program also paints the guideline markers and numbers on each individual fabric piece, thus avoiding errors during this delicate process.

The jigsaw puzzle assembly is made easier using this method and optimises the operation while making the quality control more efficient. All Niviuk gliders go through an extremely thorough and detailed final inspection. The canopy is cut and assembled under strict quality control conditions facilitated by the automation of this process.

Every wing is individually checked with a final visual inspection.

The fabric used to manufacture the glider is light, resistant and durable. The fabric will not experience fading and is covered by our warranty.

The lines are made from unsheathed Aramid and Dyneema.

The line diameter has been calculated depending on the workload and aims to achieve the required best performance with the least drag.

The lines are semi-automatically cut to length and all the sewing is completed under the supervision of our specialists.

Every line is checked and measured once the final assembly is concluded.

Each glider is packed following specific maintenance instructions as recommended by the fabric manufacturer.

Niviuk gliders are made of premium materials that meet the requirements of performance, durability and certification that the current market demands.

Information about the various materials used to manufacture the wing can be viewed in the final pages of this manual.



## 1.5 ELEMENTS, COMPONENTS

The KLIMBER 3 P is delivered with a series of accessories that will greatly assist you in the maintenance of your paraglider:

- A ZipNkare P, the new bag from Niviuk that allows you to quickly and ultra-compactly fold your lightweight paraglider and store it in perfect condition. Its extremely light weight and ergonomic handle make it easy to carry and transport, keeping the glider protected at all times.
- A repair kit with self-adhesive Ripstop tape.
- The KLIMBER 3 P is delivered with Niviuk's new Ergo P handle, which allows the pilot more comfortable, ergonomic and efficient control thanks to direct steering on the B-risers.
- An Expe Race rucksack - this is not included in the scope of the delivery, but its purchase is recommended. It facilitates transport of all the equipment comfortably and with plenty of space. It has been optimally ergonomically designed for the X-Alps athletes for maximum comfort over long distances and offers enough space for the KLIMBER 3 P and the Arrow P / Arrow P Race.

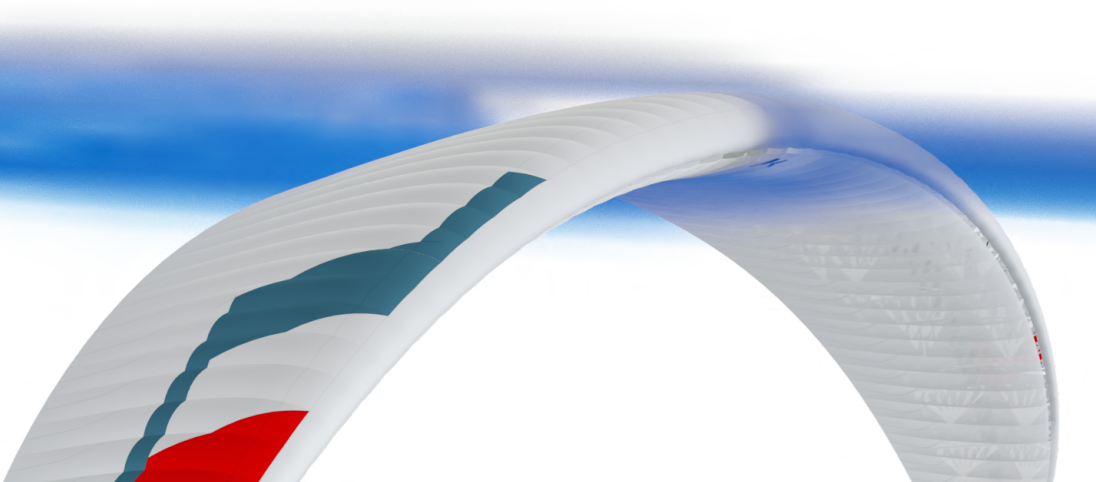

## 2. UNPACKING AND ASSEMBLY

### 2.1 CHOOSING THE RIGHT LOCATION

We recommend unpacking and assembling the wing on a training hill or a flat clear area without too much wind and free of obstacles. It will help you to carry out all the recommended steps required to check and inflate the KLIMBER 3 P.

We recommend the whole installation procedure is supervised by a qualified professional instructor or official dealer. Only they can address any doubts in a safe and professional way.

### 2.2 PROCEDURE

Take the paraglider out of the rucksack, open and unfold it on the ground with the lines positioned on the undersurface, oriented in the direction of inflation. Check the condition of the fabric and the lines for defects. Check the maillons/IKS connecting the lines to the risers to make sure they are fully closed and tightened. Identify, and if necessary, untangle, the A and B-lines, the brake lines and corresponding risers. Make sure that there are no knots.

### 2.3 CONNECTING THE HARNESS

The KLIMBER 3 P risers are colour-coded.

- Right: green
- Left: red

This colour-coding makes it easier to connect the wing to the correct side and helps prevent pre-flight errors.

Correctly connect the risers to the attachment points so that the risers and lines are correctly ordered and free of twists. Check that the IKS or carabiners are properly fastened and securely locked.

### 2.4 HARNESS TYPE

The KLIMBER 3 P can be flown with all current harness types. However, a harness with a pod is recommended as the wing is designed for flying with this type of harness. If the harness features an adjustable chest strap, we recommend setting this to the distance specified in the certification report - this will vary depending on size. See the certification certificate.

Care should be taken with the chest strap setting, as the distance of the chest strap setting will affect the handling of the glider. If the chest strap is too wide, it allows greater feedback but this carries the risk of affecting the stability of the wing.

If the chest strap is set too tightly, the wing feels more solid, but there is a loss of feedback and a risk of twisting in the case of a violent asymmetric collapse.

### 2.5 SPEED-BAR

The speed-bar is a means of temporary acceleration by changing the flow over the profile. The speed system comes pre-installed on the risers and is not modifiable as it conforms to the measurements and limits stipulated in its certification.

The KLIMBER 3 P includes a speed system with maximum travel depending on its size (see Full speed-bar).

The speed system is engaged when the pilot pushes the speed-bar (not included as standard with this glider model) with their feet (see 2.5.1 Speed system assembly).

The speed system uses an action/reaction system. Released, the speed-bar is set to neutral. When the bar is pushed using the feet, the wing accelerates. The speed can be regulated by varying the pressure on the bar. Once the pressure on the bar is released, the speed system returns to the neutral setting.

The speed system is efficient, sensitive and precise. The pilot can use the system whenever they want during the flight. In the neutral position the glider will fly at the standard speed and glide. Using full speed-bar, the wing will fly at maximum speed, but the glide will be adversely affected.

- Released speed-bar: the A and B-risers are aligned.
- Full speed-bar: the difference between the A and B-risers becomes:  
Size 20 – 19 cm  
Sizes 21 and 23 = 20 cm



Please note!

The use of the speed system results in changes to the speed and reactions of the wing. For more information, please see the certification report.

### 2.5.1 SPEED SYSTEM ASSEMBLY

The speed-bar consists of the bar that the pilot pushes with their feet, as well as the two cords that connect it to the speed system components on the risers. Once you have chosen the type of speed-bar you prefer, you must install it. Some considerations:

- You should use the type of speed-bar you consider appropriate, depending on the type of harness, personal preferences, etc.
- The speed-bar is detachable to facilitate its connection and / or disconnection to the risers as well as subsequent adjustment.
- To connect it to the harness, please follow the instructions of the harness manufacturer. The majority of harnesses have a speed system pre-installed.

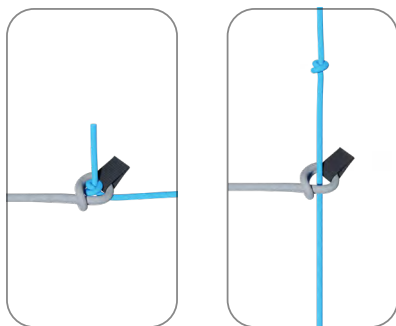

Diagram 1. Speed-bar connection by means of Kite loop (without Brummel hook)

## 2.5.2 CHANGING THE RISER CORDS

In spite of the speed system having pulleys with bearings to reduce friction to a minimum, the frequency with which the speed-bar is used causes the cord to wear and you may need to replace them.

In all Niviuk gliders the speed system cords on the risers are completely removable and easily replaceable. The pilot can use a lark's foot/clove hitch, use a different knot, use another type of connector, etc. It is even possible to fix the speed-bar cords directly to the speed system on the risers. This last option makes the connection / disconnection more laborious, but means the cord has maximum travel without obstructions or restrictions which is very useful for some models of harnesses.

## 2.6 INSPECTION AND WING INFLATION ON THE GROUND

After your gear has been thoroughly checked and the weather conditions deemed favourable for flying, inflate your KLIMBER 3 P as many times as necessary to familiarise yourself with its behaviour. Inflating the KLIMBER 3 P is easy and should not require a great deal of physical effort. Inflate the wing with a little pressure from the body using the harness. This may be assisted by using the A-lines. Do not pull on them; just accompany the natural rising movement of the wing. Once the wing is inflated to the overhead position, appropriate control with the brakes will be sufficient to hold it there.

## 2.7 ADJUSTING THE BRAKES

The length of the main brake lines are adjusted at the factory and conform to the length stipulated during certification. However, they can be changed to suit your flying style. It is advisable to fly with the original setting for a period of time to get used to the actual behaviour of the KLIMBER 3 P. In case it is necessary to modify the brake length, loosen the knot, slide the line through the brake handle to the desired point and re-tighten the knot firmly. Only qualified personnel should carry out this adjustment. You must ensure that the modification does not affect the trailing edge and slow the glider down without pilot input. Both brake lines should be symmetrical and the same length. We recommend using a clove hitch or bowline knot.

When changing the brake length, it is necessary to check that they do not engage when the speed-bar is used. When we accelerate, the glider rotates over the B-riser and the trailing edge elevates. It is important to check that the brake is adjusted to take into consideration this extra distance during acceleration. With this profile deformation there is a risk of generating turbulence and causing a frontal or asymmetric collapse.

# 3. THE FIRST FLIGHT

## 3.1 CHOOSING THE RIGHT LOCATION

For the first flight we recommend going to your usual flying area and that a qualified instructor is present and supervising the entire procedure.

## 3.2 PREPARATION

Repeat the procedures detailed in section 2 UNPACKING AND ASSEMBLY to prepare your equipment.



### 3.3 FLIGHT PLAN

It is necessary to make a flight plan in advance, to avoid possible errors in decision making.

### 3.4 PRE-FLIGHT CHECK

Once ready, but before taking off, conduct another equipment inspection. Conduct a thorough visual check of your gear with the wing fully open, the lines untangled and properly laid out on the ground to ensure that all is in working order. Be certain the weather conditions are suited to your flying skill level.

### 3.5 WING INFLATION, CONTROL AND TAKEOFF

For launch, a smooth and progressive inflation is recommended. The KLIMBER 3 P is easy to inflate and does not require a great deal of physical effort.

If the wind permits, we recommend a reverse launch, as this allows a better visual inspection of the wing during inflation. In “strong” winds, the KLIMBER 3 P is especially easy to control using this launch technique. Winds of 25 to 30 km/h are considered strong for paragliding.

Correctly setting up the wing on the ground before takeoff is especially important. Choose an appropriate location facing the wind. Position the paraglider in a crescent configuration to facilitate inflation. A clean wing layout will ensure a trouble-free take off.

### 3.6 LANDING

The KLIMBER 3 P lands excellently, it converts the wing speed into lift at your demand, allowing an enormous margin of error. Wrapping the brake lines around your hand to get greater braking efficiency is not necessary.

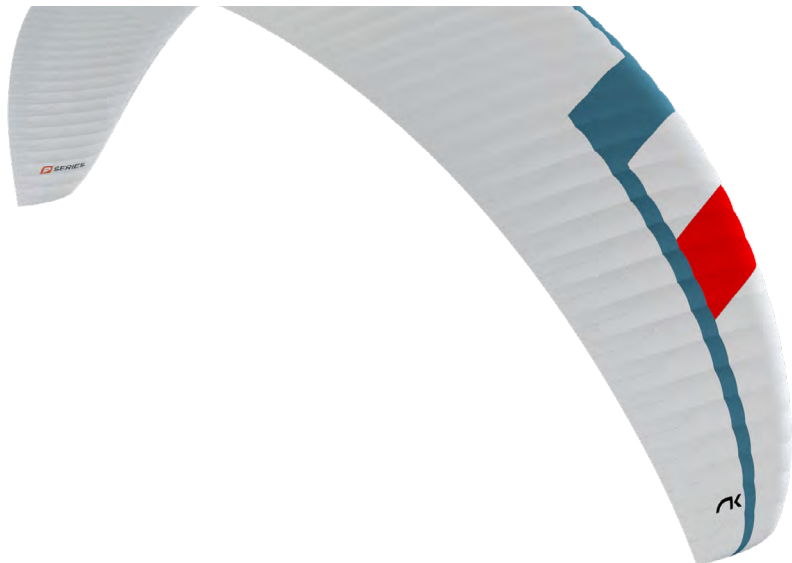

### 3.7 PACKING

The KLIMBER 3 P has a complex leading edge, manufactured using a variety of different materials and it must be packed carefully. A correct folding method is very important to extend the useful life of your paraglider.

It should be concertina-packed, with the leading edge reinforcements flat and the flexible rods stacked one on top of the other. This method will keep the profile in its original shape and protect the integrity of the wing over time. Make sure the reinforcements are not bent or folded. It should not be folded too tightly to avoid damage to the cloth and/or lines.

Niviuk have designed the NKare Bag and the ZipNkare P. These will assist you in quickly folding the paraglider, keeping the profile and integrity of the internal structures in perfect condition.

The NKare Bag will guide you through the folding process by allowing you to place the rods one on top of the other on the longitudinal axis to “concertina” pack the glider. Then you can easily make the sectional folds that each model requires. This folding system guarantees that both the cloth and the reinforcements of the internal structure remain in perfect condition. With the ZipNkare P, it is possible to perform exactly the same folding procedure and with its zip closer, becomes a much easier to carry case. It is an ultra-light bag and is specifically designed for the KLIMBER 3 P.

## 4. IN FLIGHT

We recommend that you read the certification test report.

The report contains all the necessary information on the KLIMBER 3 P reacts during each of the tested manoeuvres.

It is important to point out that the appropriate response to each adverse manoeuvre can vary from size to size; even within the same size at maximum or minimum load the behaviour and reactions of the wing may vary.

Having the knowledge that the testing house provides through the test report is fundamental to learning how to deal with possible situations.

To become familiar with the manoeuvres described below, we recommend practising within the auspices of a licensed training outfit.

### 4.1 FLYING IN TURBULENCE

The KLIMBER 3 P has an excellent profile to deal with incidents; it is very stable in all conditions and has a high degree of passive safety, even in turbulent conditions.

All paragliders must be piloted for the prevailing conditions and the pilot is the ultimate safety factor.

We recommend active flying in turbulent conditions, always taking measures to maintain control of the wing, preventing it from collapsing and restoring the speed required by the wing after each correction.

Do not correct the glider (braking) for too long in case this provokes a stall. If you have to take corrective action, make the input then re-establish the correct flying speed.

## 4.2 POSSIBLE CONFIGURATIONS

To become familiar with the manoeuvres described below, we recommend practising within the environment of a licensed training outfit. You must adapt your use of the brakes depending on the wing-loading and avoid over-steering.

It is important to note that the type of reaction to a manoeuvre can vary from one size of wing to another, and even within the same size the behaviour and reactions may be different depending on the wing-loading.

In the test report, you will find all the necessary information on how to handle your new wing during each of the tested manoeuvres. Having this information is crucial to know how to react during these manoeuvres in real flight, so you can deal with these situations as safely as possible.

### Asymmetric collapse

In spite of the KLIMBER 3 P's profile stability, strong turbulent air may cause the wing to collapse asymmetrically in very strong turbulence, especially if you do not fly actively and prevent the collapse. In this case the glider conveys a loss of pressure through the brake lines and the harness. To prevent the collapse from happening, pull the brake handle on the affected side of the wing. It will increase the incidence of the wing (angle of attack). If the collapse does happen, the KLIMBER 3 P will not react violently, the turning tendency is gradual and easily controlled. Weight-shift toward the open, flying side (the opposite side of the collapse) to keep the wing flying straight, while applying light brake pressure to that side if necessary. Normally, the collapsed side of the wing should then recover and reopen by itself. If it does not, try to weight-shift towards the collapsed side. If this does not resolve the issue, pull the brake handle on the collapsed side decisively and quickly all the way (100%) down and release it back up immediately. You may have to repeat this action to provoke the re-opening of the collapsed glider side. Do not over-brake or slow down the flying side of the wing (control the turn). Once the collapsed side is open make sure you return to normal flying speed.

### Frontal collapse

Due to the KLIMBER 3 P's design, in normal flying conditions frontal collapses are unlikely to take place. The wing's profile has great buffering abilities when dealing with extreme incidence changes. A frontal collapse may occur in strong turbulent conditions, entering or exiting powerful thermals. Frontal collapses usually re-inflate without the glider turning, but a symmetrically applied quick braking action with a quick deep pump of both brakes will accelerate the re-inflation if necessary. Release the brake lines immediately to return to default glider air speed.

### Negative spin

A negative spin does not conform to the KLIMBER 3 P's normal flight behaviour. Certain circumstances however, may provoke a negative spin (such as trying to turn when flying at very low air speed whilst applying a lot of brake). It is not easy to give any specific recommendation about this situation other than quickly restoring the wing's default air speed and angle of attack by progressively reducing the tension on the brake lines. The normal wing reaction will be to have a lateral surge on the re-accelerated side with a rotation not greater than 360° before returning to default air speed and a straight flight path trajectory.

### Parachutal stall

The possibility of entering or remaining in a parachutal stall have been eliminated from the KLIMBER 3 P. A parachutal stall is virtually impossible with this wing. If it did enter into a parachutal stall, the wing loses forward motion, becomes unstable and there is a lack of pressure on the brake lines, although the canopy

appears to be fully inflated. To regain normal air speed, release brake line tension symmetrically and manually push on the A-lines or weight-shift your body to any side WITHOUT PULLING ON THE BRAKE LINES.

### Deep Stall

The possibility of the KLIMBER 3 P stalling during normal flight is very unlikely. It could only happen if you are flying at a very low air speed, whilst over-steering or performing dangerous manoeuvres in turbulent air.

To provoke a deep stall, the wing has to be slowed down to its minimum air speed by symmetrically pulling the brake lines all the way (100%) down until the stall point is reached and held there. The glider will first pitch rearward and then reposition itself overhead, rocking slightly, depending on how the manoeuvre is done.

When entering a stall, remain clear-headed and ease off the brake lines until reaching the half-way point of the total brake travel. The wing will then surge violently forward and could reach a point below you. It is most important to maintain brake pressure until the glider has returned to its default overhead flying position.

To resume normal flight conditions, progressively and symmetrically release the brake line tension to regain air speed. When the wing reaches the overhead position, the brakes must be fully released. The wing will then surge forward to regain full air speed. Do not brake excessively at this moment as the wing needs to accelerate to pull away from the stall configuration. If you have to control a possible frontal collapse, briefly pull both brake handles down to bring the wing back up and release them immediately while the glider is still in transition to reposition itself overhead.

### Cravat

A cravat may happen after an asymmetric collapse, when the end of the wing is trapped between the lines. Depending on the nature of the tangle, this situation could rapidly cause the wing to spin. The corrective manoeuvres to use are the same as those applied in case of an asymmetric collapse: control the turn/spin by applying tension on the opposite brake and weight shift opposite to the turn. Then locate the stabilo line



(attached to the wing tip) trapped between the other lines. This line has a different colour and is located on the outside position of the A-riser.

Pull this line until it is taut. This action will help to release the cravat. If ineffective, fly down to the nearest possible landing spot, controlling the direction with both weight-shift and the use of the brake opposite to the tangled side. Be cautious when attempting to undo a tangle while flying near terrain or other paragliders; it may not be possible to continue on the intended flight path.

### Over-controlling

Most flying problems are caused by wrong pilot input, which then escalates into a cascade of unwanted and unpredicted incidents. We should note that the wrong inputs can lead to loss of control of the glider. The KLIMBER 3 P was designed to recover by itself in most cases. Do not try to over-correct it!

Generally speaking, the reactions of the wing, which are caused by too much input, are due to the length of time the pilot continues to over-control the wing. You have to allow the glider to re-establish normal flying speed and attitude after any type of incident.

## 4.3 ACCELERATED FLIGHT

The KLIMBER 3 P's profile was designed for stable flight throughout its entire speed range. The speed-bar can be used in strong winds or significant sink.

When accelerating the wing, the profile becomes more sensitive to turbulence and closer to a possible frontal collapse. If a loss in internal wing pressure is felt, tension on the speed-bar should be reduced to a minimum

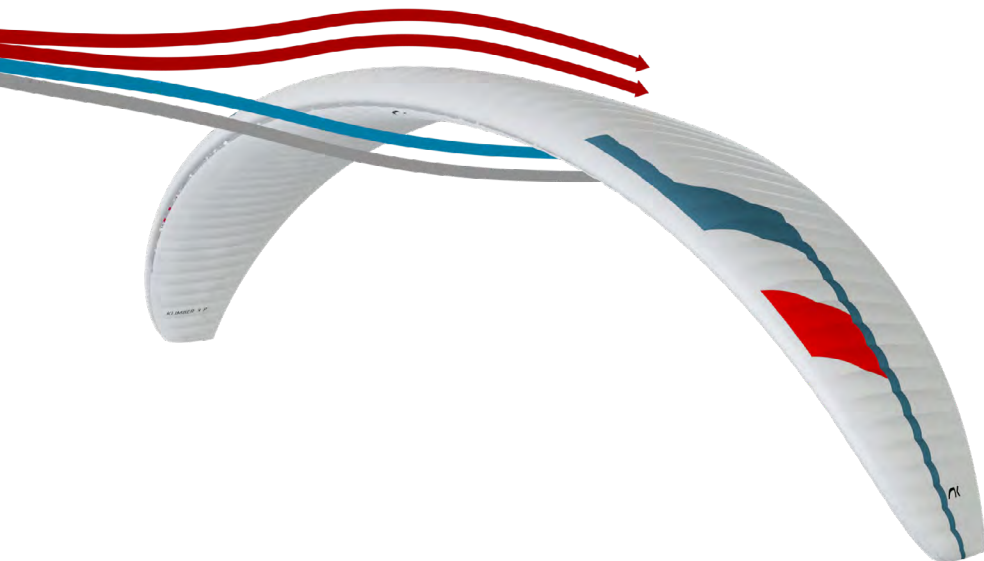

and a slight pull on the brake lines is recommended to increase the wing's incidence angle. Remember to re-establish the air speed after correcting the angle of attack.

It is NOT recommended to accelerate near obstacles or in very turbulent conditions. If necessary, constantly adjust the movements and pressure on the speed-bar whilst doing the same to the brake lines. This balance is considered to be 'active piloting'.

## 4.4 FLYING WITHOUT BRAKE LINES

If, for any reason at all, the KLIMBER 3 P's brake lines become disabled in flight, it will become necessary to pilot the wing gently using the B-risers and weight shifting until landing. These risers steer easily because are not under significant tension. You will have to be careful and not handle them too heavily in case this causes a stall or negative spin. The wing must be flown at full speed (not accelerated) during the landing approach, and the B-risers should be pulled symmetrically shortly before contact with the ground. This braking method is not as effective as using the brake lines, and hence the wing will land with a higher ground speed.

## 4.5 LINE KNOT(S) IN FLIGHT

The best way to avoid knots and tangles is to thoroughly inspect the lines as part of a systematic pre-flight check. If a knot is spotted during the take off phase, immediately abort the launch sequence and stop.

If inadvertently taking off with a knotted line, the glider drift will need to be compensated by weight-shifting to the opposite side and applying a slight brake pull to that side. Gently pull the brake line to see if the knot can be undone or try to locate the problem line. Try pulling it to see if the knot can be undone. Beware of trying to clear a knotted line or untangle a line in flight when close to the terrain. If the knot is too tight and cannot be undone, carefully and safely fly to the nearest landing zone. Be careful: do not pull too hard on the brake handles because there will be an increased risk of stalling the wing or entering a negative spin. Before attempting to clear a knot, make sure there are no other pilots flying in the vicinity.

## 5. LOSING ALTITUDE

Knowledge of different descent techniques could become vital in certain situations. The most suitable descent method will depend on the particular situation.

To become familiar with the manoeuvres described below, we recommend practising within the environment of a licensed training outfit.

### 5.1 BIG EARS

"Big Ears" is a moderate descent technique, able to increase the sink rate to  $-3$  or  $-4$  m/s and reduces the ground speed by 3 to 5 km/h. The angle of attack and effective wing-loading will also increase due to the smaller surface area of the wing.

To perform the Big Ears manoeuvre, take the 4A1 line on each A-riser and simultaneously, smoothly pull them outward and downward. The wingtips will fold in. To re-establish forward speed and the correct angle of attack, accelerate once the ears are pulled.

Keep the ears pulled in until you have lost the desired altitude.

Let go of the lines to re-inflate the tips automatically. If they do not, try progressively pulling one brake then the other. Asymmetric reopening is recommended in order to avoid compromising the angle of attack, particularly flying near the ground or in turbulent conditions.



Beware of the risk of stalling!

The action of reaching for the “4A1” line to make ears, can inadvertently mean pulling the brakes. The same can happen when we are holding the tips down with the “4A1” line, it is possible to accidentally affect the brakes. This can obviously lead to a significant speed decrease.

In paragliders with a very pronounced arc, like the KLIMBER 3 P pulling big ears means an increase in drag. On a very arched wing, the ears do not fold, they just “hang”, which increases drag.

The KLIMBER 3 P is designed with little chord, which is good in normal flight conditions. However, this same damping is what can cause us to have problems to regain normal flying speed after a high increase of the angle of attack and the added drag of the ears.

These particularities, together with turbulent thermic conditions, could cause an unintentional stall.

The solution: Big Ears may still be applied but you must be fully aware of the above-mentioned points and act accordingly. To avoid the stall, simply use half speed-bar (50% is sufficient) to increase the speed and decrease the angle of incidence. This should allow you to maintain sufficient speed to prevent the stall. It is important to remember not to use the brakes during Big Ears.

The risk of stalling does not mean that Big Ears cannot be used. This information is only provided as a guideline to prevent this situation and, should it occur, to be able to solve it in flight.

## 5.2 B3 TECHNIQUE

Even though you can use the classic ears technique, it causes great turbulences on the trailing edge. Moreover, using ears on wings with a high aspect ratio, they tend to “flap”, increasing these turbulences. It brings a speed loss that needs to be recovered by using the speed bar or releasing ears.

In 2009, the Niviuk Team pilots created a new manoeuvre for rapid descent – the B3 technique, which is performed with the 4C1 line. It was during the testing of a competition prototype that its characteristics (high aspect ratio and a new line distribution) did not allow Big Ears to be performed.

Some current two or three-liners are not very well suited to Big Ears because the risk is too high. Many advanced pilots want to have a fast and controlled descent technique, and this is when this new manoeuvre comes into play. For this reason, we recommend using the 4C1 line.

The B3 technique quickly increases the descent rate without causing the disadvantages described above. There is also no risk of stalling, as the descent takes place at a high speed at all times.

To perform this manoeuvre, locate the 4C1 line and do the same movement as you would do to make the ears: “pull” the line until the wingtips retract. At this point the glider will start to slow down and the wingtips will hang back. Then the speed will be increased slightly until it is stable again and a sink rate of 5 to 6 m/s will be achieved.

We advise you to use your speed-bar whenever you use this technique. You can control the direction by

turning using weight-shift. At the first you will notice a decrease in the relative wind and a slight tilt towards the back of the sail, as if you were going backwards.

To exit the manoeuvre, let go of the lines as you would with Big Ears and you will feel the glider gently returning to its normal rate of descent.

The B3 Technique allows you to descend quickly without the risk of a cravat. It is very comfortable and offers a lot of ease in turns.



PLEASE NOTE:

we recommend practising this manoeuvre for the first time in gentle conditions and with sufficient height. It is a safe and controlled descent technique, which only needs a little training to be performed comfortably and efficiently.

## 5.3 B-LINE STALL

It is not possible to use this descent technique with the KLIMBER 3 P.

## 5.4 SPIRAL DIVE

This is a more effective way to rapidly lose altitude. Beware that the wing will experience and be subjected to a tremendous amount of descending and rotating speed (g-force), which can cause a loss of orientation and consciousness (blackout). This manoeuvre must therefore be done gradually to increase one’s capacity to resist the g-force exerted on the body. With practise, you will fully appreciate and understand it. Only practise this manoeuvre at high altitude and with enough ground clearance.



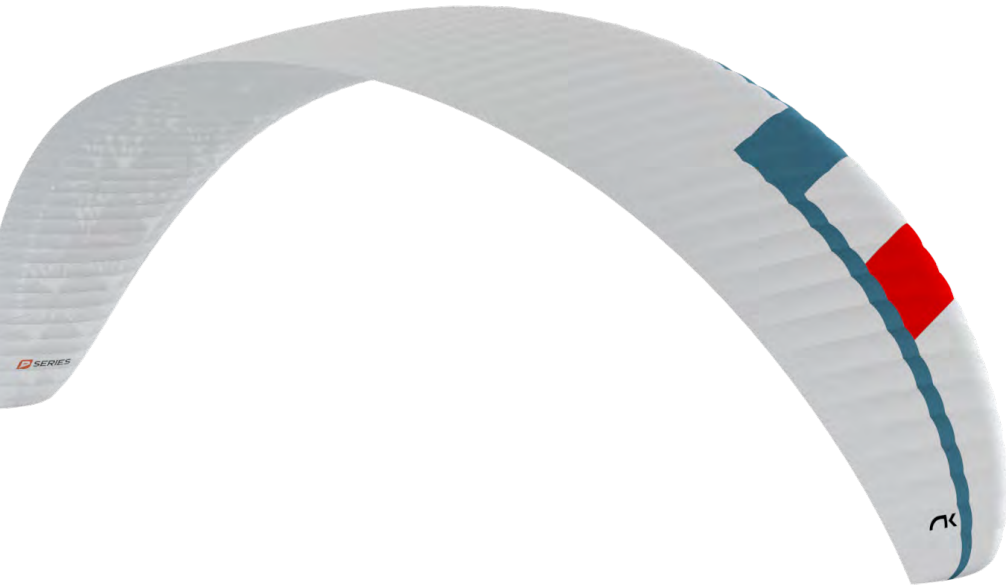

To start the manoeuvre, first weight shift and pull the brake handle located on the inner side of the turn. The intensity of the turn can be controlled by braking slightly using the outer brake handle.

A paraglider flying at its maximum rotating speed can reach  $-20$  m/s, or the equivalent of a 70 km/h vertical descent, and will stabilise in a spiral dive from 15m/s onwards.

Good enough reasons to familiarise yourself with the manoeuvre and understand how to exit it.

To exit this manoeuvre, the inner brake handle (down side of the turn) must progressively be relaxed while momentarily applying tension to the outer brake handle opposite to the turn. The pilot must also weight shift and lean towards the opposite side of the turn at the same time.

The exit should be performed gradually and smoothly so that the changes in pressure and speed can be noted.

When exiting the spiral, the glider will briefly experience an asymmetrical acceleration and dive, depending on how the manoeuvre was carried out.

Practise these manoeuvres at sufficient altitude and carefully.

## 5.5 SLOW DESCENT TECHNIQUE

This technique allows descent without straining the wing or taxing the pilot. Glide normally while searching for descending air and begin to turn as if climbing in a thermal, but with the intention to sink.

Common sense has to be used to avoid dangerous areas of rotor when looking for descending air. Safety first!

## 6. SPECIAL METHODS

### 6.1 TOWING

The KLIMBER 3 P does not experience any problem whilst being towed. Only qualified winch personnel should handle the certified equipment to carry out this operation. The wing must be inflated similarly as during a normal take off.

It is important to use the brakes to correct the flight path alignment, especially in the first phase of the tow. Since the wing is subject to a slow airspeed and with a high positive angle of attack, we must make any corrections with a high degree of feel and delicacy, in order to avoid a stall.

### 6.2 ACROBATIC FLIGHT

Although the KLIMBER 3 P was tested by expert acrobatic pilots in extreme situations, it was not designed for it. We do not recommend using this glider for acrobatic flying!!!

We consider acrobatic flights to be any form of piloting different than standard flights. Learning acrobatic manoeuvres should be conducted under the supervision of qualified instructors within a school environment and over water with all safety/rescue elements in place. Centrifugal forces as high as 4 to 5 g can be exerted on the body and wing during extreme manoeuvres.

## 7. CARE AND MAINTENANCE

### 7.1 MAINTENANCE

Careful maintenance of your equipment will ensure continued top performance. Apart from the general checks, we recommend actively maintaining your equipment.

A pre-flight check is obligatory before each flight.

If there is any damage to the equipment or you suspect any areas of the wing are susceptible to wear, you should inspect these and act accordingly.

Niviuk we are firmly committed to make technology accessible to all pilots. Therefore, our wings are equipped with the latest technological advances gained from the experience of our R&D team. Thanks to these new technologies, paragliders are gaining more safety and performance, which requires greater care of the materials.



**IMPORTANT:** it is critical to avoid any kind of impact or dragging the leading edge on the ground. This part is reinforced with very durable and strong Nitinol rods that can be easily replaced. Dragging and/or hitting the leading edge can cause serious damage to the fabric, which is much more complicated and costly to repair.

The fabric and the lines do not need to be washed. If they become dirty, clean them with a soft damp cloth, using only water. Do not use detergents or other chemicals.

If your wing is wet from contact with water, place it in a dry area, air it and keep it away from direct sunlight.

Direct sunlight may damage the wing's materials and cause premature aging. After landing, do not leave the wing exposed to the sun. Pack it properly and stow it away in its backpack.

If you fly in sandy areas, avoid getting sand in the cells or down into the trailing edge. At the end of the flight, empty any sand that is in your wing. The openings at the end of the wingtips make this much easier.

If your wing is wet from contact with salt water, immerse it in fresh water and dry it away from direct sunlight.

## 7.2 STORAGE

It is important for the wing to be correctly folded when stored. Keep it in the in a cool, dry place away from solvents, fuels, oils.

Do not leave your gear inside a car boot, as cars left in the sun can become very hot. A rucksack can reach temperatures up to 60°C.

Weight should not be laid on top of the equipment.

It is very important to pack the wing correctly before storage.

In case of long-term storage, it is advisable, if possible, that the wing is not compressed and it should be stored loosely without direct contact with the ground. Humidity and heating can have an adverse effect on the equipment.

## 7.3 CHECKS AND INSPECTIONS

The KLIMBER 3 P must be periodically serviced. An inspection must be scheduled every 100 flying hours or every two years whichever comes first (EN/LTF norm).

We strongly recommend that any repairs should be done in a specialist repair shop by qualified personnel.

This will guarantee the airworthiness and continued certification of your KLIMBER 3 P.

A thorough pre-flight check must be performed before every flight.

The KLIMBER 3 P is fitted with unsheathed lines. Their durability conforms to unsheathed line standards. Their strength is guaranteed and their resistance to UV is one of the highest in this type of lines.

The lines are made of a new waterproof coated material (Magix Pro Dry), which makes it easier to untangle knots and simplifies line sorting before flying.

However, to maintain the wing's standard performance, it is necessary to keep the trim constantly adjusted.

Generally speaking, line lengths change as the glider is used. For this reason we recommend a trim check after approximately the first 30 hours of flight. The hours or actions to be taken to repair the lines may vary for each glider, depending on the conditions of each flying area, climatic conditions, temperature, humidity, type of terrain, wing loading, etc.

Thanks to the experience acquired and the thorough inspections that our R+D team carry out on our gliders, we have the necessary information to be able to know the real behaviour of the lines. With this knowledge we can keep our gliders in the optimum condition for more flights without any loss of performance due to use.





The most important detail to check and/or repair on the lines are the so called “loops” (knots). In some models, such as the KLIMBER 3 P, the wings are delivered as standard with loops already installed. These loops must be released or readjusted according to the current line length.

Never adjust a paraglider according to the parameters of another paraglider. Each adjustment must be performed individually for each wing concerned, as a result of an analysis carried out by specialised and authorised personnel.

The line length adjustments may never exceed 1% of the length allowed by the type certification.

## 7.4 REPAIRS

In the case of small tears, you can temporarily repair these by using the Ripstop tape included in the repair kit, as long as no stitching is required to mend the fabric.

Any other tears or repairs should be done in a specialist repair shop by qualified personnel. Damaged lines must be repaired or exchanged immediately.

Please refer to the line plan at the end of this manual.

We recommend any inspection or repair is performed by a Niviuk professional in our official workshop: <https://niviuk.com/niviuk-service-form>

Any modification of the glider made in an external workshop will invalidate the guarantee of the product. Niviuk cannot be held responsible for any issues or damage resulting from modifications or repairs carried out by unqualified professionals or who are not approved by the manufacturer.

## 8. SAFETY AND RESPONSIBILITY

It is well known that free-flying with a paramotor or trike is considered a high-risk sport, where safety depends on the person who is practicing it.

Incorrect use of this equipment may cause severe, life-changing injuries to the pilot, or even death.

Manufacturers and dealers cannot be held responsible for your decisions, actions or accidents that may result from participating in this sport.

You must not use this equipment if you have not been properly trained to use it. Do not take advice or accept any informal training from anyone who is not properly qualified as a flight instructor.

## 9. GUARANTEE

The equipment and components are covered by a 2-year warranty against any manufacturing defect.

The warranty does not cover misuse of the equipment.

Any modification to the paraglider or its components invalidates the guarantee and the certification.

If you notice a fault or defect on your paraglider, contact Niviuk immediately for a full inspection.





# 10. ANNEXES

## 10.1 TECHNICAL SPECIFICATIONS

			20	21	23
<b>Cells</b>	Number		64	64	64
<b>Aspect ratio</b>	Flat		6,95	6,95	6,95
	Projected		5,32	5,32	5,32
<b>Area</b>	Flat	m2	20,3	21,5	23
	Projected	m2	17,3	18,3	19,6
<b>Span</b>	Flat	m	11,88	12,22	12,64
<b>Chord</b>	Max	m	2,15	2,22	2,29
<b>Lines</b>	Total	m	199	205	212
	Main		2-2/3	2-2/3	2-2/3
<b>Risers</b>	Number		A-A'/B	A-A'/B	A-A'/B
	Speed-bar	mm	190	200	200
<b>Glider weight</b>		kg	2,85	2,95	3,1
<b>Total weight in flight</b>	Min-Max	kg	60-78	73-93	85-105
<b>Opt. weight in flight</b>	Min-Max	kg	68-73	84-90	95-100
<b>Certification</b>			EN / LTF D	EN / LTF D	EN / LTF D

Total weight can vary +/- 2% due to variations on manufacturing process of fabric.

## COLORS



X-Alps



Astral



Ink

## 10.2 MATERIALS TECHNICAL DATA

CANOPY	FABRIC CODE	SUPPLIER
UPPER SURFACE	N10	DOMINICO TEX CO (KOREA)
BOTTOM SURFACE	N10	DOMINICO TEX CO (KOREA)
PROFILES	70000 E91	PORCHER IND (FRANCE)
DIAGONALS	70000 E91	PORCHER IND (FRANCE)
LOOPS	LKI - 10	KOLON IND. (KOREA)
REINFORCEMENT LOOPS	RIPSTOP FABRIC	DOMINICO TEX CO (KOREA)
RIBS REINFORCEMNET	LTN-0.8/0.5 STICK	SPORTWARE CO.CHINA
THREAD	SERAFIL 60	AMAN (GERMANY)

SUSPENSION LINES	FABRIC CODE	SUPPLIER
UPPER CASCADES	DC - 35	LIROS GMHB (GERMANY)
UPPER CASCADES	DC - 40	LIROS GMHB (GERMANY)
UPPER CASCADES	A-8000/U 50	EDELRID (GERMANY)
UPPER CASCADES	A-8000/U 70	EDELRID (GERMANY)
MIDDLE CASCADES	DC - 35	LIROS GMHB (GERMANY)
MIDDLE CASCADES	DC - 40	LIROS GMHB (GERMANY)
MIDDLE CASCADES	A-8000/U 50	EDELRID (GERMANY)
MIDDLE CASCADES	A-8000/U 70	EDELRID (GERMANY)
MIDDLE CASCADES	A-8000/U 90	EDELRID (GERMANY)
MIDDLE CASCADES	A-8000/U 130	EDELRID (GERMANY)
MIDDLE CASCADES	A-8000/U 190	EDELRID (GERMANY)
MAIN	A-8000/U 130	EDELRID (GERMANY)
MAIN	A-8000/U 190	EDELRID (GERMANY)
MAIN	A-8000/U 340	EDELRID (GERMANY)
MAIN BREAK	TARAX-200	EDELRID (GERMANY)
THREAD	SERAFIL 60	AMAN (GERMANY)

RISERS	FABRIC CODE	SUPPLIER
MATERIAL	CSAR7	COUSIN (FRANCE)
COLOR INDICATOR	210D	TECNI SANGLES (FRANCE)
THREAD	V138	COATS (ENGLAND)
PULLEYS	RF25109	RONSTAN (AUSTRALIA)

## 10.3 LINE PLAN

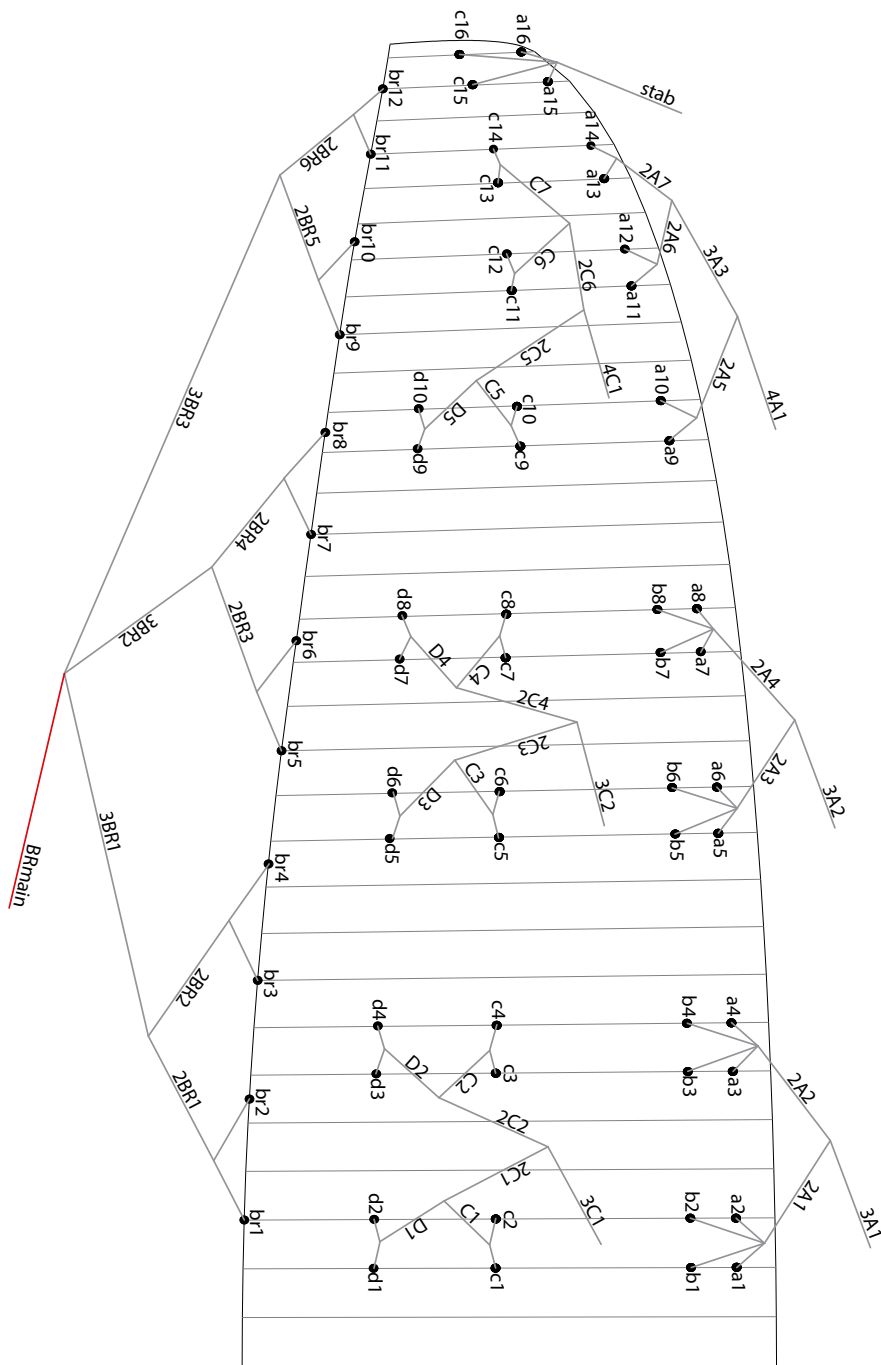

## LINE REPLACEMENT

The use of new high performance materials in modern wings is now common. The advantages of using these materials in terms of performance are widely acknowledged as part of our sport's evolution. However, along with those technological advances come additional responsibilities which cannot be avoided. As a result, line inspection and replacement must be carried out more frequently. That increased frequency appears to be encouraging some pilots to try to perform line replacement themselves.

**WE STRONGLY RECOMMEND ANY LINE REPLACEMENT IS PERFORMED BY AN AUTHORISED SPECIALIST ONLY.**

Ultimately, if the pilot decides to perform any line replacement without professional oversight they therefore assume all responsibility. In this case, these guidelines will have to be followed.

### BEFORE REMOVING ANY LINES, CHECK:

- That the line plan is correct according to the glider model and size.
- That the line kit is complete and correct. Never assume but always check each individual line for the correct specification.

### AFTER CONFIRMING THAT ALL LINES ARE CORRECT:

- Fit the new line(s) WITHOUT removing the label.
- Once replaced, measure each line length to confirm the correct measurement.
- Inflate the wing to check for any irregularities.
- The line labels may then be removed but NOT BEFORE completion of the line replacement.

*Niviuk strongly recommends any line replacement to be carried out by an authorised professional only, and will not accept responsibility for any damage or injury caused as a result of incorrect re-assembly.*

### SPECIAL CONFIGURATION ON LINES 3C1 – 3C2 – 4C1 – stab

The 3C1 – 3C2 – 4C1 – stab lines are connected to the IKS1000 by means of a loop. See diagram.

The loop is used to adjust the trim to the preset range. The loop will allow readjustment of the trim due to use, stretching or shrinking. Failure to make this loop compromises the trim of the wing and the safety of the pilot.

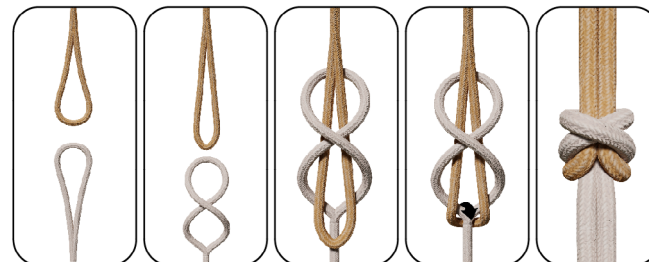

## 10.4 RISER PLAN



## 10.5 LINE MEASUREMENTS

### KLIMBER 3 P - 20

LINES HEIGHT + RISER mm

	A	B	C	D	BR
1	7222	7194	7166	7248	7390
2	7188	7158	7132	7214	7235
3	7168	7139	7111	7191	7140
4	7187	7160	7129	7206	7209
5	7121	7096	7076	7150	7029
6	7081	7055	7037	7111	6845
7	7015	6990	6976	7038	6783
8	7013	6992	6980	7035	6859
9	6863		6826	6905	6697
10	6812		6797	6865	6591
11	6689		6697		6528
12	6662		6672		6558
13	6644		6623		
14	6668		6619		
15	6469		6471		
16	6424		6455		

## 10.6 LINE MEASUREMENTS

### KLIMBER 3 P - 21

LINES HEIGHT + RISER mm

	A	B	C	D	BR
1	7428	7400	7373	7455	7617
2	7392	7362	7338	7420	7456
3	7370	7340	7315	7397	7357
4	7389	7362	7334	7412	7426
5	7320	7293	7277	7352	7240
6	7277	7251	7236	7312	7049
7	7209	7182	7171	7235	6985
8	7206	7184	7174	7232	7062
9	7052		7015	7096	6894
10	6999		6985	7054	6784
11	6870		6880		6718
12	6842		6854		6748
13	6823		6803		
14	6848		6798		
15	6641		6643		
16	6594		6626		

## 10.7 LINE MEASUREMENTS

### KLIMBER 3 P - 23

LINES HEIGHT + RISER mm

	<b>A</b>	<b>B</b>	<b>C</b>	<b>D</b>	<b>BR</b>
1	7684	7655	7628	7714	7894
2	7648	7617	7592	7678	7728
3	7628	7597	7569	7653	7626
4	7647	7619	7589	7669	7698
5	7576	7549	7530	7608	7507
6	7533	7505	7488	7566	7310
7	7463	7436	7422	7487	7244
8	7461	7437	7426	7485	7324
9	7301		7261	7344	7150
10	7246		7230	7301	7038
11	7114		7123		6971
12	7085		7095		7003
13	7065		7042		
14	7091		7037		
15	6876		6878		
16	6827		6860		

# 10.8 CERTIFICATION

AIR TURQUOISE SA | PARA-TEST.COM  
Route du Pré-au-Comte 8 • CH-1844 Villeneuve • +41 (0)21 965 65 65

Test laboratory for paragliders, paraglider harnesses and paraglider reserve parachutes



Classification: **D**

In accordance with standards EN 926-1:2015, EN 926-2:2013+A1:2021 and NF L 2-565-20  
Date of issue (DMY): 17.03.2023  
Manufacturer: Niviuk Gliders / Air Games S.L.  
Model: Klimber 3 P 20  
Serial number: KLIMBER320

**AK NIVIUK**

PG\_2152.2023

---

Configuration during flight tests

Paraglider		Accessories	
Maximum weight in flight (kg)	78	Range of speed system (cm)	18.7
Minimum weight in flight (kg)	60	Speed range using brakes (km/h)	12
Glider's weight (kg)	3	Total speed range with accessories (km/h)	36
Number of risers	2+1	Range of trimmers (cm)	0
Projected area (m2)	17.3		

Harness used for testing (max weight)		Inspections (whichever happens first)	
Harness type	ABS	every 100 hours of use or every 24 months	
Harness brand	Niviuk Gliders	Warning! Before use refer to user's manual	
Harness model	Konvers M	Person or company having presented the glider for testing: <b>None</b>	
Harness to risers distance (cm)	44		
Distance between risers (cm)	44		

1 2 3 4 5 6 7 8 9 10 11 12 13 14 15 16 17 18 19 20 21 22 23  
C A B C A A A A B D B A C D A A D D 0 A A A A

Sticker generated automatically by AIR TURQUOISE SA, valid without signature // Rev 07 | 04.03.2022 // ISO | 91.21 // Page 1 of 1

AIR TURQUOISE SA | PARA-TEST.COM  
Route du Pré-au-Comte 8 • CH-1844 Villeneuve • +41 (0)21 965 65 65

Test laboratory for paragliders, paraglider harnesses and paraglider reserve parachutes



Classification: **D**

In accordance with standards EN 926-1:2015, EN 926-2:2013+A1:2021 and NF L 2-565-20  
Date of issue (DMY): 17.03.2023  
Manufacturer: Niviuk Gliders / Air Games S.L.  
Model: Klimber 3 P 21  
Serial number: KLIMBER33121

**AK NIVIUK**

PG\_2153.2023

---

Configuration during flight tests

Paraglider		Accessories	
Maximum weight in flight (kg)	93	Range of speed system (cm)	19.3
Minimum weight in flight (kg)	73	Speed range using brakes (km/h)	12
Glider's weight (kg)	3.1	Total speed range with accessories (km/h)	36
Number of risers	2+1	Range of trimmers (cm)	0
Projected area (m2)	18.3		

Harness used for testing (max weight)		Inspections (whichever happens first)	
Harness type	ABS	every 100 hours of use or every 24 months	
Harness brand	Woody Valley	Warning! Before use refer to user's manual	
Harness model	Wani Light 2 M	Person or company having presented the glider for testing: <b>None</b>	
Harness to risers distance (cm)	43		
Distance between risers (cm)	45		

1 2 3 4 5 6 7 8 9 10 11 12 13 14 15 16 17 18 19 20 21 22 23  
C A A C A A A A D A A C D A A D B 0 A A A A

Sticker generated automatically by AIR TURQUOISE SA, valid without signature // Rev 07 | 04.03.2022 // ISO | 91.21 // Page 1 of 1

AIR TURQUOISE SA | PARA-TEST.COM  
Route du Pré-au-Comte 8 • CH-1844 Villeneuve • +41 (0)21 965 65 65

Test laboratory for paragliders, paraglider harnesses and paraglider reserve parachutes



Classification: **D**

In accordance with standards EN 926-1:2015, EN 926-2:2013+A1:2021 and NF L 2-565-20  
Date of issue (DMY): 17.03.2023  
Manufacturer: Niviuk Gliders / Air Games S.L.  
Model: Klimber 3 P 21  
Serial number: KLIMBER323

**AK NIVIUK**

PG\_2154.2023

---

Configuration during flight tests

Paraglider		Accessories	
Maximum weight in flight (kg)	105	Range of speed system (cm)	19.8
Minimum weight in flight (kg)	85	Speed range using brakes (km/h)	12
Glider's weight (kg)	3.3	Total speed range with accessories (km/h)	36
Number of risers	2+1	Range of trimmers (cm)	0
Projected area (m2)	19.6		

Harness used for testing (max weight)		Inspections (whichever happens first)	
Harness type	ABS	every 100 hours of use or every 24 months	
Harness brand	Niviuk Gliders	Warning! Before use refer to user's manual	
Harness model	Konvers M	Person or company having presented the glider for testing: <b>None</b>	
Harness to risers distance (cm)	44		
Distance between risers (cm)	47		

1 2 3 4 5 6 7 8 9 10 11 12 13 14 15 16 17 18 19 20 21 22 23  
C A B C A A A A B D A A C D A A D B 0 A A A A

Sticker generated automatically by AIR TURQUOISE SA, valid without signature // Rev 07 | 04.03.2022 // ISO | 91.21 // Page 1 of 1



## Niviuk Paragliders

C/ Del Ter 6 - D

17165 La Cellera de Ter - Girona - Spain

+34 972 422 878 | [info@niviuk.com](mailto:info@niviuk.com)

[www.niviuk.com](http://www.niviuk.com)

