

HOOK 6

Technical *specifications*



PIVIUK BEYOND
THE GLIDE

TECHNICAL SPECIFICATIONS

			20	22	24	26	28	31
Cells	Number		47	47	47	47	47	47
Aspect ratio	Flat		5,3	5,3	5,3	5,3	5,3	5,3
	Projected		4	4	4	4	4	4
Area	Flat	m2	20	22	24	26	28	31
	Projected	m2	17,15	18,87	20,59	22,3	24,02	26,59
Span	Flat	m	10,3	10,8	11,28	11,74	12,18	12,82
Chord	Max	m	2,43	2,55	2,66	2,77	2,87	3,02
Lines	Total	m	205	215	226	235	244	258
	Main		2-1/3/2	2-1/3/2	2-1/3/2	2-1/3/2	2-1/3/2	2-1/3/2
Risers	Number	3+1	A-A' /B/C	A-A' /B/C	A-A' /B/C	A-A' /B/C	A-A' /B/C	A-A' /B/C
	Speed-bar	mm	145	145	145	145	145	145
Glider weight		kg	3,97	4,2	4,5	4,8	5,1	5,5
Total weight in flight	Min-Max	kg	55-70	60-80	70-92	80-105	95-120	110-135
Certification			EN/LTF B	EN/LTF B	EN/LTF B	EN/LTF B	EN/LTF B	EN/LTF B

The total weight of the wing may differ $\pm 2\%$ due to variations in the weight of the fabric supplied by the manufacturers.

MATERIALS

CANOPY	FABRIC CODE	SUPPLIER
UPPER SURFACE	30 DMF / N20 DMF	DOMINICO TEX CO (KOREA)
BOTTOM SURFACE	N20 DMF	DOMINICO TEX CO (KOREA)
PROFILES	30 DFM	DOMINICO TEX CO (KOREA)
DIAGONALS	30 DFM	DOMINICO TEX CO (KOREA)
LOOPS	LKI - 12	KOLON IND. (KOREA)
REINFORCEMENT LOOPS	RIPSTOP FABRIC	DOMINICO TEX CO (KOREA)
TRAILING EDGE REINFORCEMENT	MYLAR	D-P (GERMANY)
RIBS REINFORCEMENT	LTN-0.8/0.5 STICK	SPORTWARE CO.CHINA
THREAD	SERAFIL 60	AMAN (GERMANY)

SUSPENSION LINES	FABRIC CODE	SUPPLIER
UPPER CASCADES	A-8001/U 50	EDELRID (GERMANY)
UPPER CASCADES	A-8001/U 70	EDELRID (GERMANY)
UPPER CASCADES	A-8001/U 130	EDELRID (GERMANY)
UPPER CASCADES	TNL-80	TEIJIM LIMITED (JAPAN)
MIDDLE CASCADES	A-8001/U 50	EDELRID (GERMANY)
MIDDLE CASCADES	TNL-80	TEIJIM LIMITED (JAPAN)
MIDDLE CASCADES	TNL-140	TEIJIM LIMITED (JAPAN)
MIDDLE CASCADES	TNL-220	TEIJIM LIMITED (JAPAN)
MAIN	TNL-80	TEIJIM LIMITED (JAPAN)
MAIN	TNL-280	TEIJIM LIMITED (JAPAN)
MAIN BREAK	TARAX-200	EDELRID (GERMANY)
THREAD	SERAFIL 60	AMAN (GERMANY)

RISERS	FABRIC CODE	SUPPLIER
MATERIAL	3455	COUSIN (FRANCE)
COLOR INDICATOR	210D	TECNI SANGLES (FRANCE)
THREAD	V138	COATS (ENGLAND)
MAILLONS	3.5	ANSUNG PRECISION (KOREA)
PULLEYS	SB15	RONSTAN (AUSTRALIA)

SUSPENSION PLAN

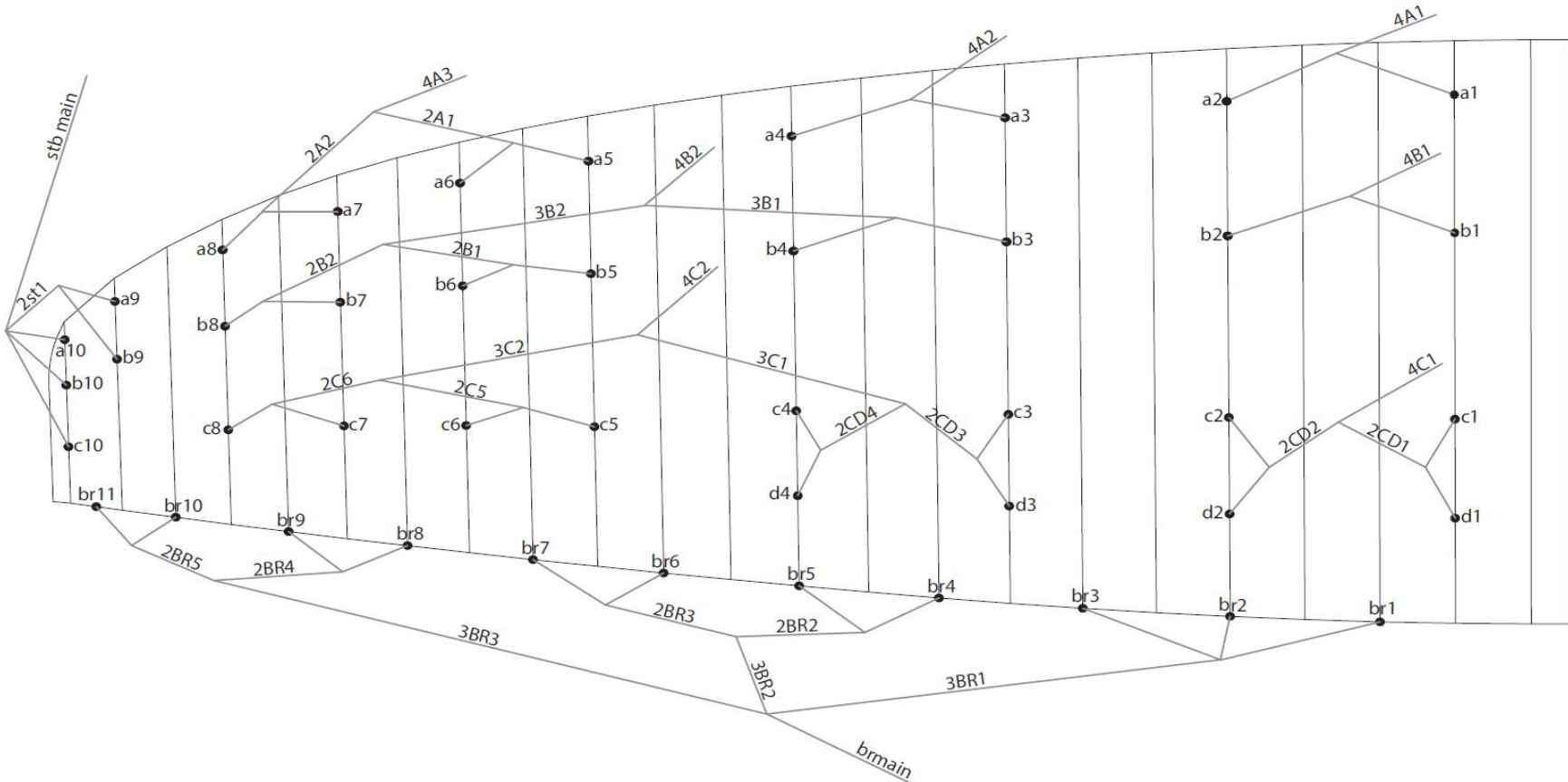

RISERS PLAN

A	A'	B	C
4A1	4A3	4B1	4C1
4A2		4B2	4C2
		stb main	

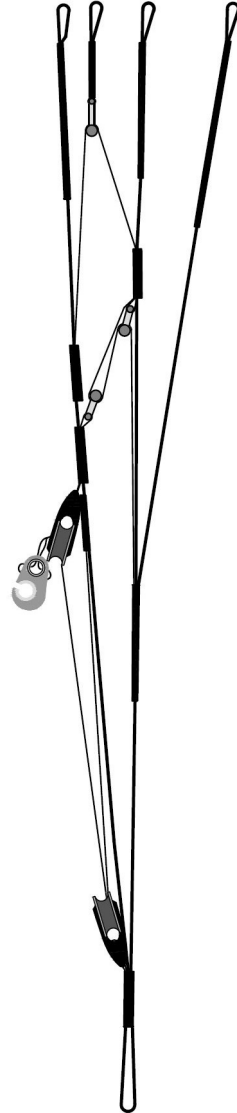

COLORS

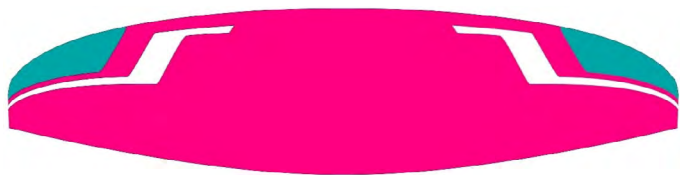

NEON	SB1	PINK	TOP	REF: 19-2047
	SB2	WHITE	BOTTOM - ALL WHITE	REF: 001
	SB3	SPECTRA GREEN	HORN	REF: 17-5335
	SB4	WHITE	SHADOW	REF: 001

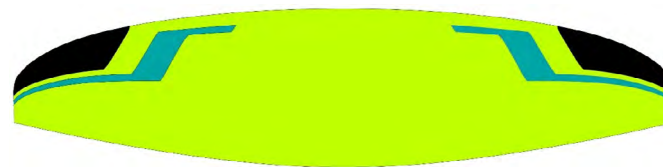

MATRIX	SB1	LIMA	TOP	REF: 500
	SB2	WHITE	BOTTOM - ALL WHITE	REF: 001
	SB3	BLACK	HORN	REF: 102
	SB4	SPECTRA GREEN	SHADOW	REF: 17-5335



TEKNO	SB1	SLATE BLUE	TOP	REF: 317
	SB2	WHITE	BOTTOM - ALL WHITE	REF: 001
	SB3	GOLD	HORN	REF: 939
	SB4	WHITE	SHADOW	REF: 001

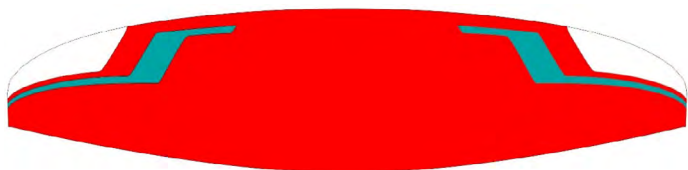

SPICY	SB1	DRAGON RED	TOP	REF: 636
	SB2	WHITE	BOTTOM - ALL WHITE	REF: 001
	SB3	WHITE	HORN	REF: 001
	SB4	SPECTRA GREEN	SHADOW	REF: 17-5335

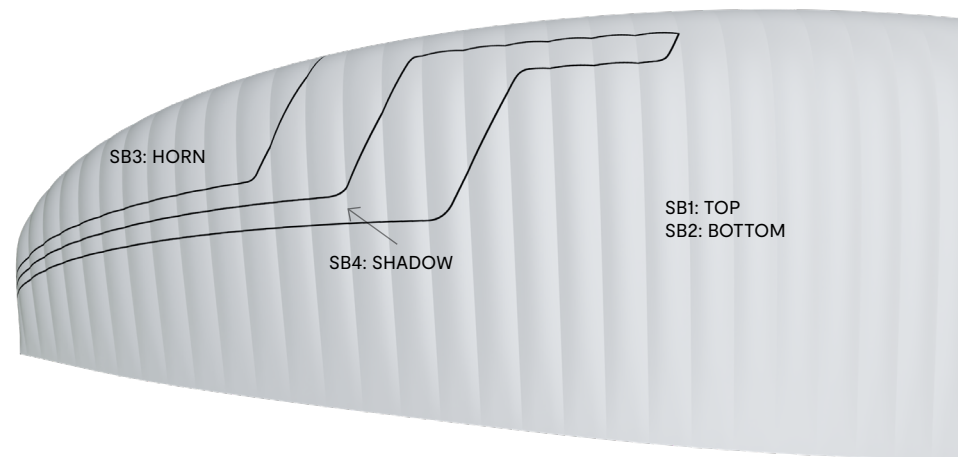

WING LOAD

HOOK 6

20		22		24		26		28		31	
P.T.V.	KG/M2	P.T.V.	KG/M2	P.T.V.	KG/M2	P.T.V.	KG/M2	P.T.V.	KG/M2	P.T.V.	KG/M2
55	= 2,75	60	= 2,73	72	= 3,00	80	= 3,08	95	= 3,39	110	= 3,55
56	= 2,80	61	= 2,77	73	= 3,04	81	= 3,12	96	= 3,43	111	= 3,58
57	= 2,85	62	= 2,82	74	= 3,08	82	= 3,15	97	= 3,46	112	= 3,61
58	= 2,90	63	= 2,86	75	= 3,13	83	= 3,19	98	= 3,50	113	= 3,65
59	= 2,95	64	= 2,91	76	= 3,17	84	= 3,23	99	= 3,54	114	= 3,68
60	= 3,00	65	= 2,95	77	= 3,21	85	= 3,27	100	= 3,57	115	= 3,71
61	= 3,05	66	= 3,00	78	= 3,25	86	= 3,31	101	= 3,61	116	= 3,74
62	= 3,10	67	= 3,05	79	= 3,29	87	= 3,35	102	= 3,64	117	= 3,77
63	= 3,15	68	= 3,09	80	= 3,33	88	= 3,38	103	= 3,68	118	= 3,81
64	= 3,20	69	= 3,14	81	= 3,38	89	= 3,42	104	= 3,71	119	= 3,84
65	= 3,25	70	= 3,18	82	= 3,42	90	= 3,46	105	= 3,75	120	= 3,87
66	= 3,30	71	= 3,23	83	= 3,46	91	= 3,50	106	= 3,79	121	= 3,90
67	= 3,35	72	= 3,27	84	= 3,50	92	= 3,54	107	= 3,82	122	= 3,94
68	= 3,40	73	= 3,32	85	= 3,54	93	= 3,58	108	= 3,86	123	= 3,97
69	= 3,45	74	= 3,36	86	= 3,58	94	= 3,62	109	= 3,89	124	= 4,00
70	= 3,50	75	= 3,41	87	= 3,63	95	= 3,65	110	= 3,93	125	= 4,03
		76	= 3,45	88	= 3,67	96	= 3,69	111	= 3,96	126	= 4,06
		77	= 3,50	89	= 3,71	97	= 3,73	112	= 4,00	127	= 4,10
		78	= 3,55	90	= 3,75	98	= 3,77	113	= 4,04	128	= 4,13
		79	= 3,59	91	= 3,79	99	= 3,81	114	= 4,07	129	= 4,16
		80	= 3,64	92	= 3,83	100	= 3,85	115	= 4,11	130	= 4,19
						101	= 3,88	116	= 4,14	131	= 4,23
						102	= 3,92	117	= 4,18	132	= 4,26
						103	= 3,96	118	= 4,21	133	= 4,29
						104	= 4,00	119	= 4,25	134	= 4,32
						105	= 4,04	120	= 4,29	135	= 4,35

LINES TECHNICAL DATA

HOOK 6 20

REF.	MAT.	kg	COLOR	mm	REF.	MAT.	kg	COLOR	mm	REF.	MAT.	kg	COLOR	mm	MAT.	kg	COLOR	mm	REF.	MAT.	kg	COLOR	mm	
A					B					C					D					BRAKE				
a1	8001/U	130	BLUE	1761	b1	8001/U	130	BLUE	1740	c1	8001/U	50	BLUE	1004	d1	8001/U	50	BLUE	1112	br1	TNL	80	RED	1721
a2	8001/U	130	BLUE	1718	b2	8001/U	130	BLUE	1695	c2	8001/U	50	BLUE	979	d2	8001/U	50	BLUE	1083	br2	TNL	80	RED	1510
a3	8001/U	130	BLUE	1643	b3	8001/U	130	BLUE	1626	c3	8001/U	50	BLUE	928	d3	8001/U	50	BLUE	1029	br3	TNL	80	RED	1446
a4	8001/U	130	BLUE	1607	b4	8001/U	130	BLUE	1552	c4	8001/U	50	BLUE	862	d4	8001/U	50	BLUE	953	br4	TNL	80	RED	851
a5	8001/U	70	BLUE	1018	b5	8001/U	70	BLUE	997	c5	8001/U	50	BLUE	899						br5	TNL	80	RED	704
a6	8001/U	70	BLUE	878	b6	8001/U	70	BLUE	903	c6	8001/U	50	BLUE	812						br6	TNL	80	RED	700
a7	8001/U	70	BLUE	967	b7	8001/U	70	BLUE	898	c7	8001/U	50	BLUE	778						br7	TNL	80	RED	751
a8	8001/U	70	BLUE	905	b8	8001/U	70	BLUE	893	c8	8001/U	50	BLUE	794						br8	TNL	80	RED	678
a9	8001/U	50	BLUE	722	b9	8001/U	50	BLUE	697	c10	8001/U	50	BLUE	1381						br9	TNL	80	RED	552
a10	8001/U	50	BLUE	1317	b10	8001/U	50	BLUE	1316										br10	TNL	80	RED	549	
																			br11	TNL	80	RED	460	
2A1	TNL	140	GREEN	1028	2B1	TNL	140	BLUE	887	2CD1	TNL	140	BLUE	533					2BR2	TNL	80	Red	737	
2A2	TNL	140	GREEN	842	2B2	TNL	80	BLUE	846	2CD2	TNL	140	BLUE	518					2BR3	TNL	80	RED	690	
2ST1	8001/U	50	BLUE	699	3B1	TNL	220	BLUE	2094	2CD3	TNL	140	BLUE	524					2BR4	TNL	80	RED	578	
					3B2	TNL	140	BLUE	1721	2CD4	TNL	80	BLUE	481					2BR5	TNL	80	RED	475	
										2C5	TNL	80	BLUE	823					3BR1	TNL	80	RED	2297	
										2C6	TNL	80	BLUE	826					3BR2	TNL	80	RED	2161	
										3C1	TNL	220	BLUE	1808					3BR3	TNL	80	RED	2335	
										3C2	TNL	80	BLUE	1392										
4A1	TNL	280	GREEN	4114	4B1	TNL	280	BLUE	4035	4C1	TNL	280	BLUE	4282					BRMAIN	TARAX	200	RED	2637	
4A2	TNL	280	GREEN	4153	4B2	TNL	280	BLUE	2036	4C2	TNL	280	BLUE	2586					KNOT POINT:				2437	
4A3	TNL	280	GREEN	3682	STB MAIN	TNL	80	RED	3818															

LINES TECHNICAL DATA

HOOK 6 22

REF.	MAT.	kg	COLOR	mm	REF.	MAT.	kg	COLOR	mm	REF.	MAT.	kg	COLOR	mm	MAT.	kg	COLOR	mm	REF.	MAT.	kg	COLOR	mm	
A					B					C					D					BRAKE				
a1	8001/U	130	BLUE	1847	b1	8001/U	130	BLUE	1825	c1	8001/U	50	BLUE	1053	d1	8001/U	50	BLUE	1166	br1	TNL	80	RED	1805
a2	8001/U	130	BLUE	1803	b2	8001/U	130	BLUE	1778	c2	8001/U	50	BLUE	1027	d2	8001/U	50	BLUE	1136	br2	TNL	80	RED	1583
a3	8001/U	130	BLUE	1724	b3	8001/U	130	BLUE	1705	c3	8001/U	50	BLUE	974	d3	8001/U	50	BLUE	1079	br3	TNL	80	RED	1516
a4	8001/U	130	BLUE	1686	b4	8001/U	130	BLUE	1628	c4	8001/U	50	BLUE	905	d4	8001/U	50	BLUE	1000	br4	TNL	80	RED	892
a5	8001/U	70	BLUE	1068	b5	8001/U	70	BLUE	1046	c5	8001/U	50	BLUE	943						br5	TNL	80	RED	738
a6	8001/U	70	BLUE	921	b6	8001/U	70	BLUE	947	c6	8001/U	50	BLUE	851						br6	TNL	80	RED	734
a7	8001/U	70	BLUE	1014	b7	8001/U	70	BLUE	942	c7	8001/U	50	BLUE	817						br7	TNL	80	RED	787
a8	8001/U	70	BLUE	948	b8	8001/U	70	BLUE	936	c8	8001/U	50	BLUE	833						br8	TNL	80	RED	706
a9	8001/U	50	BLUE	757	b9	8001/U	50	BLUE	731	c10	8001/U	50	BLUE	1448						br9	TNL	80	RED	574
a10	8001/U	50	BLUE	1381	b10	8001/U	50	BLUE	1380										br10	TNL	80	RED	571	
																			br11	TNL	80	RED	485	
2A1	TNL	140	GREEN	1078	2B1	TNL	140	BLUE	930	2CD1	TNL	140	BLUE	559					2BR2	TNL	80	Red	773	
2A2	TNL	140	GREEN	882	2B2	TNL	80	BLUE	887	2CD2	TNL	140	BLUE	544					2BR3	TNL	80	RED	724	
2ST1	8001/U	50	BLUE	733	3B1	TNL	220	BLUE	2196	2CD3	TNL	140	BLUE	550					2BR4	TNL	80	RED	601	
					3B2	TNL	140	BLUE	1804	2CD4	TNL	80	BLUE	504					2BR5	TNL	80	RED	498	
										2C5	TNL	80	BLUE	864					3BR1	TNL	80	RED	2406	
										2C6	TNL	80	BLUE	865					3BR2	TNL	80	RED	2263	
										3C1	TNL	220	BLUE	1896					3BR3	TNL	80	RED	2455	
										3C2	TNL	80	BLUE	1459										
4A1	TNL	280	GREEN	4338	4B1	TNL	280	BLUE	4253	4C1	TNL	280	BLUE	4514					BRMAIN	TARAX	200	RED	2741	
4A2	TNL	280	GREEN	4379	4B2	TNL	280	BLUE	2159	4C2	TNL	280	BLUE	2735					KNOT POINT:				2541	
4A3	TNL	280	GREEN	3885	STB MAIN	TNL	80	RED	4026															

LINES TECHNICAL DATA

HOOK 6 24

REF.	MAT.	kg	COLOR	mm	REF.	MAT.	kg	COLOR	mm	REF.	MAT.	kg	COLOR	mm	MAT.	kg	COLOR	mm	REF.	MAT.	kg	COLOR	mm	
A					B					C					D					BRAKE				
a1	8001/U	130	BLUE	1929	b1	8001/U	130	BLUE	1906	c1	8001/U	50	BLUE	1100	d1	8001/U	50	BLUE	1218	br1	TNL	80	RED	1885
a2	8001/U	130	BLUE	1883	b2	8001/U	130	BLUE	1858	c2	8001/U	50	BLUE	1073	d2	8001/U	50	BLUE	1187	br2	TNL	80	RED	1654
a3	8001/U	130	BLUE	1800	b3	8001/U	130	BLUE	1781	c3	8001/U	50	BLUE	1017	d3	8001/U	50	BLUE	1127	br3	TNL	80	RED	1584
a4	8001/U	130	BLUE	1760	b4	8001/U	130	BLUE	1700	c4	8001/U	50	BLUE	945	d4	8001/U	50	BLUE	1044	br4	TNL	80	RED	932
a5	8001/U	70	BLUE	1115	b5	8001/U	70	BLUE	1092	c5	8001/U	50	BLUE	985						br5	TNL	80	RED	771
a6	8001/U	70	BLUE	961	b6	8001/U	70	BLUE	989	c6	8001/U	50	BLUE	888						br6	TNL	80	RED	767
a7	8001/U	70	BLUE	1059	b7	8001/U	70	BLUE	984	c7	8001/U	50	BLUE	853						br7	TNL	80	RED	822
a8	8001/U	70	BLUE	990	b8	8001/U	70	BLUE	978	c8	8001/U	50	BLUE	870						br8	TNL	80	RED	742
a9	8001/U	50	BLUE	791	b9	8001/U	50	BLUE	763	c10	8001/U	50	BLUE	1512						br9	TNL	80	RED	605
a10	8001/U	50	BLUE	1442	b10	8001/U	50	BLUE	1441										br10	TNL	80	RED	601	
																			br11	TNL	80	RED	503	
2A1	TNL	140	GREEN	1127	2B1	TNL	140	BLUE	972	2CD1	TNL	140	BLUE	584					2BR2	TNL	80	Red	807	
2A2	TNL	140	GREEN	920	2B2	TNL	80	BLUE	926	2CD2	TNL	140	BLUE	568					2BR3	TNL	80	RED	756	
2ST1	8001/U	50	BLUE	766	3B1	TNL	220	BLUE	2294	2CD3	TNL	140	BLUE	574					2BR4	TNL	80	RED	633	
					3B2	TNL	140	BLUE	1884	2CD4	TNL	80	BLUE	525					2BR5	TNL	80	RED	520	
										2C5	TNL	80	BLUE	903					3BR1	TNL	80	RED	2517	
										2C6	TNL	80	BLUE	903					3BR2	TNL	80	RED	2367	
										3C1	TNL	220	BLUE	1981					3BR3	TNL	80	RED	2558	
										3C2	TNL	80	BLUE	1523										
4A1	TNL	280	GREEN	4552	4B1	TNL	280	BLUE	4462	4C1	TNL	280	BLUE	4735					BRMAIN	TARAX	200	RED	2903	
4A2	TNL	280	GREEN	4595	4B2	TNL	280	BLUE	2276	4C2	TNL	280	BLUE	2878					KNOT POINT:				2703	
4A3	TNL	280	GREEN	4078	STB MAIN	TNL	80	RED	4224															

LINES TECHNICAL DATA

HOOK 6 26

REF.	MAT.	kg	COLOR	mm	REF.	MAT.	kg	COLOR	mm	REF.	MAT.	kg	COLOR	mm	MAT.	kg	COLOR	mm	REF.	MAT.	kg	COLOR	mm	
A					B					C					D					BRAKE				
a1	8001/U	130	BLUE	2007	b1	8001/U	130	BLUE	1983	c1	8001/U	50	BLUE	1145	d1	8001/U	50	BLUE	1267	br1	TNL	80	RED	1962
a2	8001/U	130	BLUE	1961	b2	8001/U	130	BLUE	1935	c2	8001/U	50	BLUE	1117	d2	8001/U	50	BLUE	1235	br2	TNL	80	RED	1722
a3	8001/U	130	BLUE	1873	b3	8001/U	130	BLUE	1854	c3	8001/U	50	BLUE	1059	d3	8001/U	50	BLUE	1173	br3	TNL	80	RED	1649
a4	8001/U	130	BLUE	1833	b4	8001/U	130	BLUE	1770	c4	8001/U	50	BLUE	983	d4	8001/U	50	BLUE	1087	br4	TNL	80	RED	969
a5	8001/U	70	BLUE	1161	b5	8001/U	70	BLUE	1137	c5	8001/U	50	BLUE	1025						br5	TNL	80	RED	803
a6	8001/U	70	BLUE	1001	b6	8001/U	70	BLUE	1031	c6	8001/U	50	BLUE	925						br6	TNL	80	RED	798
a7	8001/U	70	BLUE	1103	b7	8001/U	70	BLUE	1024	c7	8001/U	50	BLUE	888						br7	TNL	80	RED	857
a8	8001/U	70	BLUE	1031	b8	8001/U	70	BLUE	1018	c8	8001/U	50	BLUE	906						br8	TNL	80	RED	772
a9	8001/U	50	BLUE	823	b9	8001/U	50	BLUE	795	c10	8001/U	50	BLUE	1574						br9	TNL	80	RED	629
a10	8001/U	50	BLUE	1501	b10	8001/U	50	BLUE	1500										br10	TNL	80	RED	626	
																			br11	TNL	80	RED	525	
2A1	TNL	140	GREEN	1172	2B1	TNL	140	BLUE	1011	2CD1	TNL	140	BLUE	607					2BR2	TNL	80	Red	840	
2A2	TNL	140	GREEN	959	2B2	TNL	80	BLUE	965	2CD2	TNL	140	BLUE	593					2BR3	TNL	80	RED	788	
2ST1	8001/U	50	BLUE	797	3B1	TNL	220	BLUE	2386	2CD3	TNL	140	BLUE	597					2BR4	TNL	80	RED	659	
					3B2	TNL	140	BLUE	1962	2CD4	TNL	80	BLUE	548					2BR5	TNL	80	RED	542	
										2C5	TNL	80	BLUE	939					3BR1	TNL	80	RED	2616	
										2C6	TNL	80	BLUE	941					3BR2	TNL	80	RED	2464	
										3C1	TNL	220	BLUE	2061					3BR3	TNL	80	RED	2665	
										3C2	TNL	80	BLUE	1587										
4A1	TNL	280	GREEN	4758	4B1	TNL	280	BLUE	4664	4C1	TNL	280	BLUE	4949					BRMAIN	TARAX	200	RED	3055	
4A2	TNL	280	GREEN	4806	4B2	TNL	280	BLUE	2393	4C2	TNL	280	BLUE	3020					KNOT POINT:				2855	
4A3	TNL	280	GREEN	4270	STB MAIN	TNL	80	RED	4423															

LINES TECHNICAL DATA

HOOK 6 28

REF.	MAT.	kg	COLOR	mm	REF.	MAT.	kg	COLOR	mm	REF.	MAT.	kg	COLOR	mm	MAT.	kg	COLOR	mm	REF.	MAT.	kg	COLOR	mm	
A					B					C					D					BRAKE				
a1	8001/U	130	BLUE	2082	b1	8001/U	130	BLUE	2057	c1	8001/U	50	BLUE	1188	d1	8001/U	50	BLUE	1315	br1	TNL	80	RED	2036
a2	8001/U	130	BLUE	2036	b2	8001/U	130	BLUE	2009	c2	8001/U	50	BLUE	1159	d2	8001/U	50	BLUE	1282	br2	TNL	80	RED	1787
a3	8001/U	130	BLUE	1944	b3	8001/U	130	BLUE	1923	c3	8001/U	50	BLUE	1099	d3	8001/U	50	BLUE	1217	br3	TNL	80	RED	1713
a4	8001/U	130	BLUE	1903	b4	8001/U	130	BLUE	1838	c4	8001/U	50	BLUE	1021	d4	8001/U	50	BLUE	1128	br4	TNL	80	RED	1005
a5	8001/U	70	BLUE	1205	b5	8001/U	70	BLUE	1180	c5	8001/U	50	BLUE	1063						br5	TNL	80	RED	833
a6	8001/U	70	BLUE	1039	b6	8001/U	70	BLUE	1070	c6	8001/U	50	BLUE	960						br6	TNL	80	RED	829
a7	8001/U	70	BLUE	1144	b7	8001/U	70	BLUE	1063	c7	8001/U	50	BLUE	921						br7	TNL	80	RED	890
a8	8001/U	70	BLUE	1070	b8	8001/U	70	BLUE	1057	c8	8001/U	50	BLUE	940						br8	TNL	80	RED	801
a9	8001/U	50	BLUE	854	b9	8001/U	50	BLUE	825	c10	8001/U	50	BLUE	1633						br9	TNL	80	RED	653
a10	8001/U	50	BLUE	1558	b10	8001/U	50	BLUE	1556										br10	TNL	80	RED	649	
																			br11	TNL	80	RED	545	
2A1	TNL	140	GREEN	1216	2B1	TNL	140	BLUE	1049	2CD1	TNL	140	BLUE	629						2BR2	TNL	80	Red	872
2A2	TNL	140	GREEN	996	2B2	TNL	80	BLUE	1003	2CD2	TNL	140	BLUE	616						2BR3	TNL	80	RED	818
2ST1	8001/U	50	BLUE	827	3B1	TNL	220	BLUE	2475	2CD3	TNL	140	BLUE	620						2BR4	TNL	80	RED	683
					3B2	TNL	140	BLUE	2037	2CD4	TNL	80	BLUE	569						2BR5	TNL	80	RED	562
										2C5	TNL	80	BLUE	974						3BR1	TNL	80	RED	2712
										2C6	TNL	80	BLUE	977						3BR2	TNL	80	RED	2557
										3C1	TNL	220	BLUE	2138						3BR3	TNL	80	RED	2769
										3C2	TNL	80	BLUE	1648										
4A1	TNL	280	GREEN	4956	4B1	TNL	280	BLUE	4857	4C1	TNL	280	BLUE	5154						BRMAIN	TARAX	200	RED	3157
4A2	TNL	280	GREEN	5009	4B2	TNL	280	BLUE	2507	4C2	TNL	280	BLUE	3157						KNOT POINT:				2957
4A3	TNL	280	GREEN	4455	STB MAIN	TNL	80	RED	4615															

LINES TECHNICAL DATA

HOOK 6 31

REF.	MAT.	kg	COLOR	mm	REF.	MAT.	kg	COLOR	mm	REF.	MAT.	kg	COLOR	mm	MAT.	kg	COLOR	mm	REF.	MAT.	kg	COLOR	mm	
A					B					C					D					BRAKE				
a1	8001/U	130	BLUE	2189	b1	8001/U	130	BLUE	2163	c1	8001/U	50	BLUE	1250	d1	8001/U	50	BLUE	1384	br1	TNL	80	RED	2141
a2	8001/U	130	BLUE	2144	b2	8001/U	130	BLUE	2116	c2	8001/U	50	BLUE	1220	d2	8001/U	50	BLUE	1349	br2	TNL	80	RED	1881
a3	8001/U	130	BLUE	2045	b3	8001/U	130	BLUE	2023	c3	8001/U	50	BLUE	1156	d3	8001/U	50	BLUE	1281	br3	TNL	80	RED	1804
a4	8001/U	130	BLUE	2003	b4	8001/U	130	BLUE	1935	c4	8001/U	50	BLUE	1074	d4	8001/U	50	BLUE	1187	br4	TNL	80	RED	1057
a5	8001/U	70	BLUE	1268	b5	8001/U	70	BLUE	1242	c5	8001/U	50	BLUE	1119						br5	TNL	80	RED	877
a6	8001/U	70	BLUE	1094	b6	8001/U	70	BLUE	1127	c6	8001/U	50	BLUE	1011						br6	TNL	80	RED	872
a7	8001/U	70	BLUE	1204	b7	8001/U	70	BLUE	1118	c7	8001/U	50	BLUE	969						br7	TNL	80	RED	938
a8	8001/U	70	BLUE	1127	b8	8001/U	70	BLUE	1113	c8	8001/U	50	BLUE	989						br8	TNL	80	RED	842
a9	8001/U	50	BLUE	899	b9	8001/U	50	BLUE	868	c10	8001/U	50	BLUE	1718						br9	TNL	80	RED	688
a10	8001/U	50	BLUE	1639	b10	8001/U	50	BLUE	1638										br10	TNL	80	RED	684	
																			br11	TNL	80	RED	574	
2A1	TNL	140	GREEN	1279	2B1	TNL	140	BLUE	1104	2CD1	TNL	140	BLUE	660						2BR2	TNL	80	Red	917
2A2	TNL	140	GREEN	1049	2B2	TNL	80	BLUE	1058	2CD2	TNL	140	BLUE	650						2BR3	TNL	80	RED	861
2ST1	8001/U	50	BLUE	870	3B1	TNL	220	BLUE	2603	2CD3	TNL	140	BLUE	652						2BR4	TNL	80	RED	719
					3B2	TNL	140	BLUE	2145	2CD4	TNL	80	BLUE	599						2BR5	TNL	80	RED	592
										2C5	TNL	80	BLUE	1024						3BR1	TNL	80	RED	2849
										2C6	TNL	80	BLUE	1029						3BR2	TNL	80	RED	2691
										3C1	TNL	220	BLUE	2249						3BR3	TNL	80	RED	2918
										3C2	TNL	80	BLUE	1736										
4A1	TNL	400	GREEN	5240	4B1	TNL	280	BLUE	5136	4C1	TNL	280	BLUE	5449						BRMAIN	TARAX	200	RED	3336
4A2	TNL	400	GREEN	5301	4B2	TNL	280	BLUE	2669	4C2	TNL	280	BLUE	3353						KNOT POINT:				3136
4A3	TNL	280	GREEN	4721	STB MAIN	TNL	80	RED	4891															

LINE MEASUREMENTS

HOOK 6 - 20

LINES HEIGHT MM

	A	B	C	D	br
1	6390	6289	6328	6436	6490
2	6347	6244	6288	6392	6279
3	6311	6256	6343	6444	6215
4	6275	6182	6235	6326	6212
5	6233	6134	6201		6065
6	6093	6040	6114		6014
7	5996	5996	6083		6065
8	5934	5991	6099		6054
9	5755	5730	5718		5928
10	5654	5653			5822
11					5733

RISERS LENGHT MM

	A	B	C	D	
	500	500	500	500	STANDARD
	380	398	418	500	ACCELERATED

HOOK 6 - 22

LINES HEIGHT MM

	A	B	C	D	br
1	6700	6593	6635	6748	6787
2	6656	6546	6594	6703	6565
3	6618	6561	6652	6757	6498
4	6580	6484	6538	6633	6495
5	6536	6433	6502		6341
6	6389	6334	6410		6288
7	6286	6288	6377		6341
8	6220	6282	6393		6329
9	6032	6007	5993		6197
10	5926	5926			6091
11					6005

RISERS LENGHT MM

	A	B	C	D	
	500	500	500	500	STANDARD
	335	380	403	500	ACCELERATED

LINE MEASUREMENTS

HOOK 6 - 24

LINES HEIGHT MM

	A	B	C	D	br
1	6996	6882	6928	7046	7140
2	6950	6834	6885	6999	6909
3	6910	6851	6947	7057	6839
4	6870	6770	6827	6926	6835
5	6825	6717	6790		6674
6	6671	6614	6693		6619
7	6562	6565	6658		6674
8	6493	6559	6675		6662
9	6297	6269	6255		6525
10	6185	6184			6408
11					6310

RISERS LENGHT MM

	A	B	C	D	
	500	500	500	500	STANDARD
	355	380	403	500	ACCELERATED

HOOK 6 - 26

LINES HEIGHT MM

	A	B	C	D	br
1	7280	7162	7210	7332	7468
2	7234	7114	7168	7286	7228
3	7194	7134	7234	7348	7155
4	7154	7050	7110	7214	7154
5	7108	6997	7072		6988
6	6948	6891	6972		6931
7	6837	6840	6937		6990
8	6765	6834	6955		6977
9	6559	6532	6516		6834
10	6443	6443			6714
11					6613

RISERS LENGHT MM

	A	B	C	D	
	500	500	500	500	STANDARD
	355	380	403	500	ACCELERATED

LINE MEASUREMENTS

HOOK 6 - 28

LINES HEIGHT MM

	A	B	C	D	br
1	7553	7428	7480	7607	7740
2	7507	7380	7438	7561	7491
3	7468	7405	7511	7629	7417
4	7427	7320	7383	7490	7417
5	7381	7266	7343		7245
6	7215	7156	7240		7187
7	7100	7105	7204		7248
8	7026	7099	7223		7236
9	6812	6783	6767		7088
10	6692	6690			6963
11					6859

RISERS LENGHT MM

	A	B	C	D	
	500	500	500	500	STANDARD
	355	380	403	500	ACCELERATED

HOOK 6 - 31

LINES HEIGHT MM

	A	B	C	D	br
1	7944	7813	7868	8002	8161
2	7899	7766	7828	7957	7901
3	7861	7795	7907	8032	7824
4	7819	7707	7773	7886	7827
5	7773	7653	7733		7647
6	7599	7538	7625		7586
7	7479	7485	7588		7652
8	7402	7480	7608		7641
9	7176	7145	7128		7487
10	7049	7048			7356
11					7246

RISERS LENGHT MM

	A	B	C	D	
	500	500	500	500	STANDARD
	355	380	403	500	ACCELERATED

SUSPENSION TECHNICAL DATA

MATERIAL CODE		TNL	TNL	TNL	TNL	A-8000/U	A-8000/U	A-8000/U	TARAX
STRENGTH CODE		080	140	220	280	050	070	130	200
DIAMETER m/m	∅	1,1	1,4	1,6	1,8	0,5	0,7	0,9	1,7
CORE MATERIAL		Technora	Technora	Technora	Technora	ARAMID	ARAMID	ARAMID	Dyneema
SLEEVE MATERIAL		Polyester	Polyester	Polyester	Polyester	NO	NO	NO	Polyester
WEIGHT G/M	TOTAL	1,1	1,2	1,6	2,7	0,3	0,4	0,8	2
BREAKING STRENGTH daN	MINIMUM	80	140	220	280	50	70	130	200
	MAXIMUM	92	160	250	320	59	78	144	
STRENGTH AFTER									
5.000 BENDING	TEST EN	36,7	76,1	114,2	134,7	26	39	88	
CYCLES									
ELONGATION AT	5 daN en %	0,3	0,2	0,2	0,2	0,4	0,5	0,4	0,1-0,3
	10 daN en %	0,5	0,3	0,3	0,3	0,7	0,7	0,6	0,2-0,6
	15 daN en %	0,7	0,5	0,5	0,4	1,1	1	0,8	0,3-0,7
	20 daN en %	1	0,6	0,6	0,4	1,5	1,3	0,9	0,3-0,9
	25 daN en %	1,3	0,8	0,7	0,5	1,9	1,5	1	0,4-1
	30 daN en %	2,3	1,5	1,2	0,9	3,3	2,8	1,8	
	75 daN en %	2,8	2,3	1,8	1,3		3,7	3,1	0,8-1,7
	100 daN en %		2,7	2,2	1,7				1,2-2
	125 daN en %		3,2	2,7	2				
	150 daN en %			3	2,3				1,6-2,4
175 daN en %			3,3	2,7					
200 daN en %			3,8	2,8				2-2,8	
ELONGATION MAX. BREAKING STRENGTH %		3	3,4	4	4,1	3,8	3,9	4	

MAILLON & PULLEY TECHNICAL DATA

DESCRIPTION

MAILLON	DELTA
CODE	3.5
MATERIAL	STAINLESS STEEL
SIZE	3 m/m
WEIGHT	5 G/PIECE
QUANTITY	8 PIECES
INSERTS	2 GREEN / 6 BLACK

TECHNICAL SPECIFICATIONS

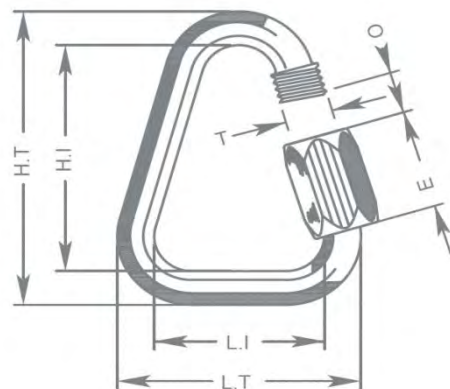

DIMENSIONS	m/m
L.T.	22
L.I.	14
H.T.	37
H.I.	29
O	5
E	12
T	4
LOAD	KG
WORKING LIMIT	110
BREAKING	550

MATERIAL

AISI 304 STAINLESS STEEL	STANDARD
--------------------------	----------

CLOSING APPLIED BY MANUAL & ENTIRE SCREWING OF THE NUT
TO GUARANTEE THE HIGHEST SAFETY (NO THREAD SHOULD BE OBVIOUS)

SYSTEMATIC CONTROL OF MAILLON QUICK-LINKS BEFORE EVERY FLIGHT

DESCRIPTION PULLEY

PULLEY	20 M/M
CODE	RF25109
MATERIALS	STAINLESS STEEL
	NYLON
	CARBON ACETAL
BEARING	DELRIN®
WEIGHT	14 G/PIECE

TECHNICAL SPECIFICATIONS

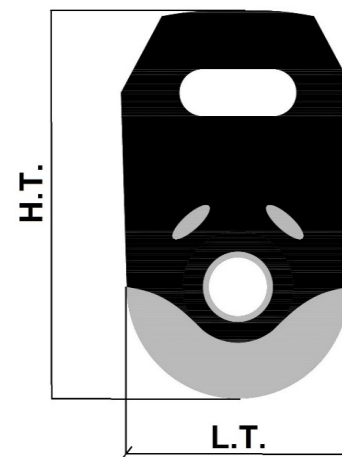

DIMENSIONS	m/m
L.T.	20
H.T.	33
Ø	5 MAX
LOAD	KG
WORKING LIMIT	200
BREAKING	400

THREAD

SAIL MAKING

NAME	SERAFIL
Nº OF REFERENCE	60
MATERIAL	POLYESTER
TYPE OF FINISH	SILK
LINEAR DENSITY	NM 61 / 3 (DTEX 163 * 3)
BREAKING STRENGTH	3,000 CN
ELONGATION	17,00%

PROPIETIES SERAFIL

SOLIDITY ARTIFICIAL LIGTH	ISO 105 B02 > 5 - 6
SOLIDITY SWEAT	ISO 105 E04 > 4
SOLIDITY WASHING	ISO 105 C04 > 3
SOLIDITY GRAZE IN DRY	ISO 105 X12 > 4
SOLIDITY WASHING IN DRY	ISO 105 D01 > 3 - 4

TREATMENT WATER REPELLENT	WR
---------------------------	----

RISERS MAKING

NOMBRE	COATS BONDED C.F.P.
Nº DE REFERENCIA	V138
MATERIAL	POLYESTER
ACABADO	SILK
RESISTENCIA A LA TRACCIÓN	9,5 KG

RISERS

RISERS

REFERENCIA	3455
MATERIAL	POLYESTER & TECHNORA
ANCHO	12 mm
GRUESO	2,25 mm
RESISTENCIA A LA TRACCIÓN	1.100 DAN
ALARGAMIENTO	MAX. 11%
PESO	21,1 G/M
COLOR	BLACK

COLOR INDICATOR

REFERENCIA	IC-G 1-2
MATERIAL	POLYESTER
ANCHO	70 M/M
GRUESO	0,80 M/M
RESISTENCIA A LA TRACCIÓN	130 DN
ALARGAMIENTO	35 %
PESO	32 G * L.M.
COLOR	GREEN

LOOPS

REFERENCIA	LKI - 10
MATERIAL	NYLON
ANCHO	10 M/M
RESISTENCIA A LA TRACCIÓN	84 KG
ALARGAMIENTO	30 %
PESO	5,5 G/M



Niviuk Paragliders

C/ Del Ter 6 - nave D
17165 La Cellera de Ter - Girona - Spain
+34 972 422 878 | info@niviuk.com
www.niviuk.com